

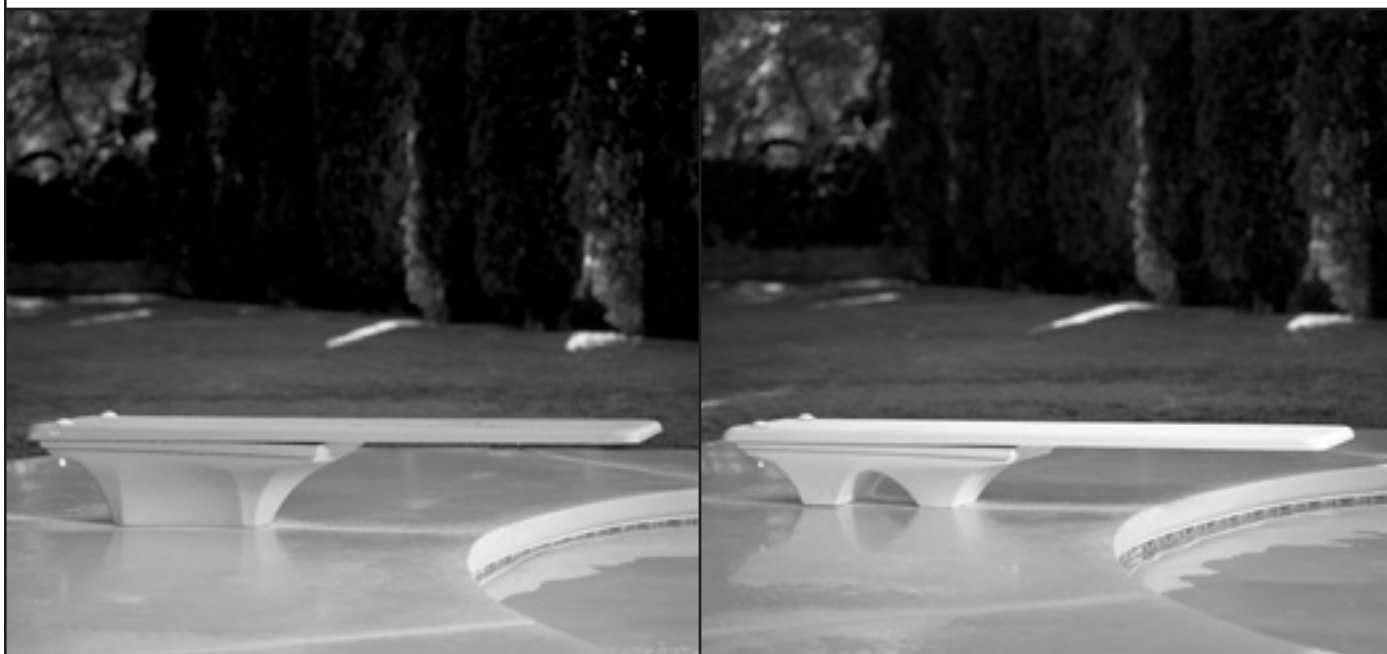

**DURO-BEAM DIVING BOARD
LA MESA/LOS ARCOS STAND
Assembly & Installation Instructions**



**3050 S. ALVERNON WAY • TUCSON, AZ 85713
520.790.7040 • 800.737.5386 • FAX 520.790.7127**

inter-fab.com

For Technical Support or Assistance,
Contact Customer Service at:

**INTER-FAB, INC.
3050 S. ALVERNON WAY
TUCSON, AZ 85713
(800) 737-5386**

or visit: www.inter-fab.com

To obtain complete copies of the ANSI/NSPI-5 2003
Standard for Residential Inground Pools or to obtain
copies of the “Plan Your Dive, Steer Up” or “The
Sensible Way to Enjoy Your Inground Swimming Pool”
contact:

**The Association of Pool & Spa Professionals
(APSP)
2111 Eisenhower Ave.
Alexandria, VA 22314
(703) 838-0083**

or visit: www.theapsp.org

TABLE OF CONTENTS:

Safety First2

Intended Use Instructions3

Important Notices to the Installer.....4

Minimum Diving Water Envelope Information.....5

La Mesa Base Placement6

Los Arcos Base Placement7

Duro-Beam Board Dimensions & Fulcrum Settings8

La Mesa/Los Arcos Jig Information8

Installation Instructions9

La Mesa Exploded View & Parts List10

Los Arcos Exploded View & Parts List11

Paver Kit Information.....12

Article 5 Extracted from ANSI/NSPI-5 200313-18

Pages for Notes19-20

Inter-Fab Limited Warranty.....21

SAFETY FIRST!

This Inter-Fab diving board and stand shall be installed only by a professional swimming pool contractor or with the direct supervision of a licensed professional, engineer or architect. Diving boards may be installed only on residential inground swimming pools properly designed for their use.

Diving boards that are improperly installed can be very dangerous to the user resulting in possible serious head and/or spinal column injury, including the paralysis or death of the user.

It is very important that this diving board and/or stand be installed only on a pool that is built in strict accordance with the American National Standard for Residential Inground Swimming Pools (ANSI/NSPI-5 2003) and in strict accordance with the included INTER-FAB RESIDENTIAL POOL SPECIFICATIONS TABLE 2. Under no circumstances can this diving board and/or stand be installed on any above ground or on-ground swimming pool.

In addition to the above standard and referenced table, these installation instructions provided by Inter-Fab, Inc. must be diligently followed.

It is also important that any and all warnings provided with the diving board be strictly adhered to and posted in a conspicuous location. If not provided or they are misplaced, please purchase warning signs from your pool contractor or professional pool supply store and post them in a location that the users of the diving board can clearly see.

**FOR RESIDENTIAL INGROUND SWIMMING POOL USE ONLY
NO COMMERCIAL, PUBLIC OR SEMI-PUBLIC USE IS ALLOWED
ONLY ONE PERSON ON THE DIVING BOARD AT ONE TIME
MAXIMUM WEIGHT = 250 LBS**

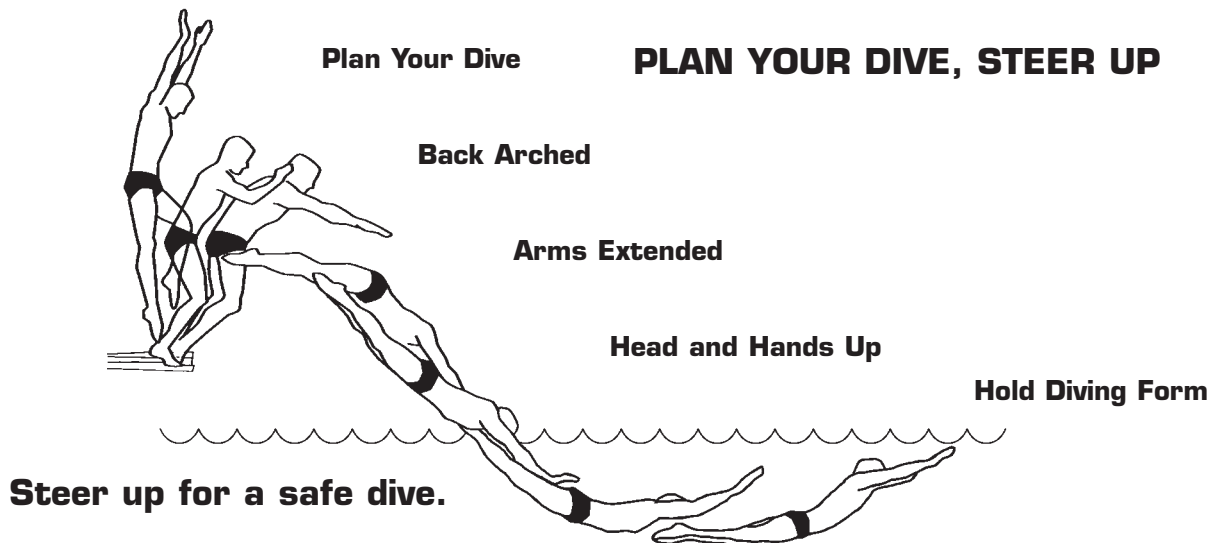

DIVING TIPS: Even the safest equipment must be used properly. Inter-Fab promotes safe diving by offering these tips on the proper use of your diving board: always dive into water that meets depth requirements, with arms extended; be aware of the bottom and the walls of the pool; avoid collisions with pool toys and floats; and instruct your pool users to always “steer up”. When you begin your dive you must get ready to steer up. As you enter the water, your arms must be extended over your head, hands flat aiming up. Hold your head and arch your back.

INTENDED USE INSTRUCTIONS

“A pool is the safest place to swim and a diving board installed in compliance with manufacturers instructions and the ANSI/NSPI-5 2003 Standard for In-ground Residential Pools is the safest place to dive from. To ensure that you and your family and guests are able to safely enjoy your diving board for many years, it is critical that you follow the following instructions.”

DO

1. Know the shape and depth of the pool before you dive.
2. Make sure that all family members and guests are familiar with these instructions before they use your pool and diving board.
3. Make sure that the diving board has been installed in compliance with the Assembly and Installation Instructions and with the ANSI/NSPI-5 2003 Standard for In-ground Residential Pools. This includes the shape and depth of the pool as well as the height of the diving board.
4. Enter feet first the first time.
5. Plan your path to be sure you avoid any other swimmers, or objects in or under the water, such as floats, tires, toys etc.
6. Keep your head up, arms up and fully extended and **steer up** with your hands.
7. Practice carefully before you dive headfirst.
8. Become familiar with the diving board and its spring before diving headfirst
9. Dive straight ahead, not to the side of the board or pool.
10. Dive from the diving board only.
11. Make sure that children and non-swimmers are supervised at all times.
12. Always remember that when you dive you **must steer up**.
13. Inspect your diving board, base and stand on a regular basis (at least twice a year) and keep them in proper repair.
14. Contact your dealer, installer or Inter Fab (800-737-5386) with any questions or concerns about the safe use of your diving board.

DON'T

1. Don't drink and dive.
2. Don't install this or any diving board on an above ground pool or dive into an above ground pool from any surface.
3. Never install any Inter-Fab diving board on a variable fulcrum dive stand.
4. Don't dive into a pool from anyplace not specifically designated for diving. Never dive into the shallow portion of any pool.
5. Don't dive across the width of the pool or to the sides of the pool.
6. Don't Run and dive.
7. Don't engage in horseplay in or around the diving board or pool.
8. Don't use your diving board as a trampoline.
9. Don't do a back dive. Backyard pools are not built for that type of activity.
10. Don't try fancy dives. Keep the dives simple.
11. Don't dive into or through objects or toys such as inner tubes.
12. Don't swim or dive alone.
13. Don't use a diving board or stand or base that is rusted or worn out or in poor repair.

IMPORTANT NOTICES TO THE INSTALLER

The specifications found on page 5 of this manual represent the **minimum** water envelope required by Inter-fab and by the ANSI/NSPI-5 2003 Standard for residential Inground Swimming Pools. Each of these dimensions must be met or exceeded. Installation of a diving board of any type on a pool that does not meet or exceed each of the minimum specifications as provided on page 5 including but not limited to the slope requirement, is in direct violation of this manufacturer's instructions and the 2003 Standard, and can result in serious injury or death.

Installation of this La Mesa / Los Arcos Dive Stand and/or Duro-Beam Diving Board is limited to Residential Inground Pools only.

A 6' diving board can only be installed on a 6' dive stand; an 8' diving board can only be installed on a 8' stand, a 10' diving board can only be installed on a 10' stand.

Inter-Fab Duro-Beam Diving Boards are designed for use on fixed fulcrum dive stands. Installation on any variable fulcrum dive stand is strictly prohibited.

Comply with local government regulations for Residential Inground Swimming Pools if they exceed the ANSI/NSPI-5 2003 Standard for Residential Inground Swimming Pools

When installing any Duro-Beam Diving Board to any dive stand you must ensure the board is mounted with the correct distance from the board mounting bolt holes to the fulcrum. See Table 5 - Board Dimensions and Fulcrum Settings on page 8.

Read carefully pages 13–18 of this installation manual which contain portions of the ANSI/NSPI-5 2003 Standard for Residential Inground Swimming Pools, ensure that you understand Figure 3 and Table 1 provided in the ANSI/NSPI-5 2003 Standard.

NOTE: The installation of this La Mesa / Los Arcos Dive Stand and/or Duro-Beam Diving Board is not complete until you, the installer have measured the pool as well as the diving board's height above water and the fulcrum distance to ensure they meet the Inter-Fab's Residential Pool Minimum Specifications and the ANSI/NSPI-5 2003 Standard for Residential Inground Swimming Pools. In addition; the installation of this diving board is not complete until you the installer have delivered to your customer and reviewed with your customer the "Owners Manual" as well as the "Plan Your Dive Steer-Up" brochure.

**THE DURO-BEAM BOARD & LA MESA/LOS ARCOS STAND
ARE A DIVING BOARD.**

**ONLY ONE PERSON AT A TIME ON THE DIVING BOARD,
WITH A MAXIMUM WEIGHT LIMIT OF 250 LBS.**

MINIMUM DIVING WATER ENVELOPE:

NOTE: DRAWINGS ARE NOT TO SCALE.

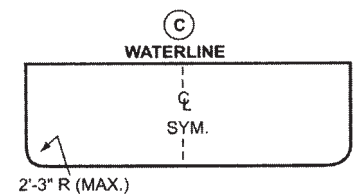
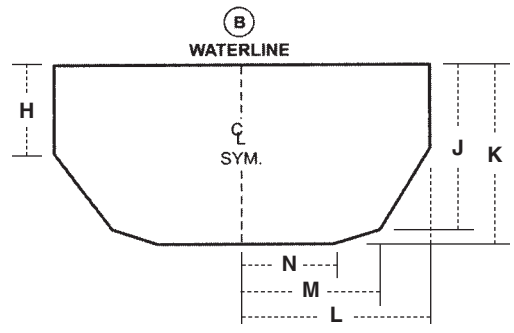
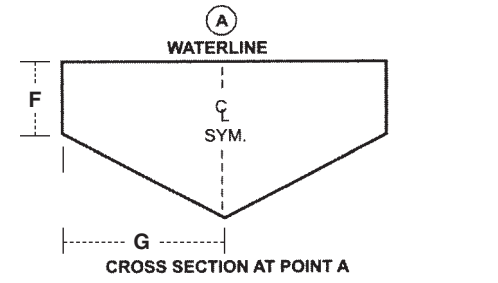
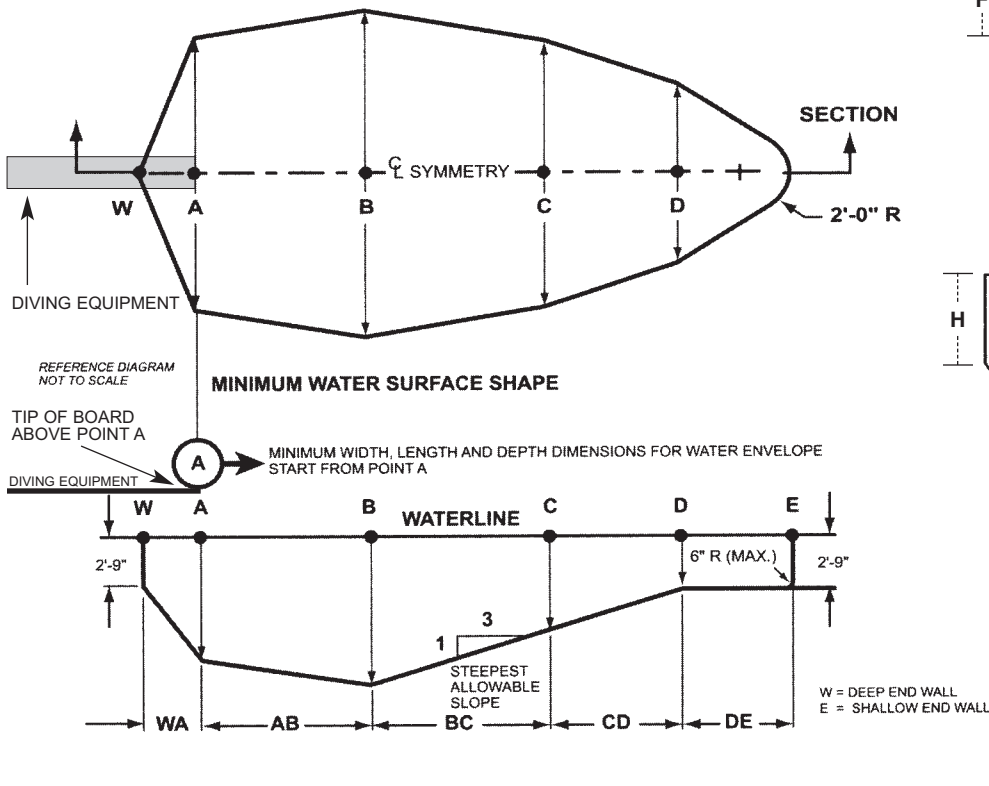

CROSS SECTION AT POINT C

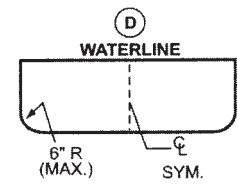

CROSS SECTION AT POINT D

TABLE 1 - MINIMUM WATER ENVELOPE (ANSI/NSPI-5 2003)

POOL TYPE	MINIMUM DEPTHS AT POINT				MINIMUM WIDTHS AT POINT				MINIMUM LENGTHS BETWEEN POINTS					
	A	B	C	D	A	B	C	D	WA+/-3"	AB	BC	CD*	DE	WE
0	DIVING EQUIPMENT PROHIBITED													
I	6'-0"	7'-6"	5'-0"	2'-9"	10'-0"	12'-0"	10'-0"	8'-0"	1'-6"	7'-0"	7'-6"	VARIES	6'-0"	28'-9"
II	6'-0"	7'-6"	5'-0"	2'-9"	12'-0"	15'-0"	12'-0"	8'-0"	1'-6"	7'-0"	7'-6"	VARIES	6'-0"	28'-9"
III	6'-10"	8'-0"	5'-0"	2'-9"	12'-0"	15'-0"	12'-0"	8'-0"	2'-0"	7'-6"	9'-0"	VARIES	6'-0"	31'-3"
IV	7'-8"	8'-6"	5'-0"	2'-9"	15'-0"	18'-0"	15'-0"	9'-0"	2'-6"	8'-0"	10'-6"	VARIES	6'-0"	33'-9"
V	8'-6"	9'-0"	5'-0"	2'-9"	15'-0"	18'-0"	15'-0"	9'-0"	3'-0"	9'-0"	12'-0"	VARIES	6'-0"	36'-9"

TABLE 2 - INTER-FAB RESIDENTIAL POOL MINIMUM SPECIFICATIONS

POOL TYPE	MAX. DIVING BOARD LENGTH	MAX. HEIGHT OVER WATER AT POINT A	CROSS SECTIONAL DIMENSIONS AT POINT A		CROSS SECTIONAL DIMENSIONS AT POINT B						MIN. HEAD ROOM ABOVE DIVING SURFACES
	DBL**	HOW**	F	G	H	J	K	L	M	N	
0	DIVING EQUIPMENT PROHIBITED										
I	6' DB/6' JB	20"	2'-9"	5'-0"	4'-0"	7'-2.5"	7'-6"	6'-0"	3'-9"	2'-1.5"	12'
II	8' DB/6' JB	20"	2'-9"	3'-10"	4'-2"	7'-2.5"	7'-6"	6'-8"	3'-9"	2'-1.5"	12'
III	10' DB/8' JB	26"	2'-9"	4'-4.75"	4'-4.5"	7'-5.5"	8'-0"	6'-7"	3'-11.5"	1'-7.5"	13'
IV	10' DB/8' JB	30"	2'-9"	5'-10.5"	3'-10"	7'-8"	8'-6"	8'-3"	5'-7"	2'-7"	13'
V	12' DB/8' JB	40"	2'-9"	6'-2"	3'-11.5"	7'-9.5"	9'-0"	8'-2.5"	5'-9"	2'-7"	14'

*Min. length between points CD may vary based upon water depth at point D and the slope between points C & D
 ABBREVIATIONS: **DBL=Diving Board Length; DB=Diving Board; JB=Jump Board; **HOW=Height Over Water

NOTES:

NOTE: READ THESE INSTRUCTIONS IN THEIR ENTIRETY BEFORE ATTEMPTING THE INSTALLATION.

FIG. A – LA MESA PLACEMENT SPECIFICATIONS:

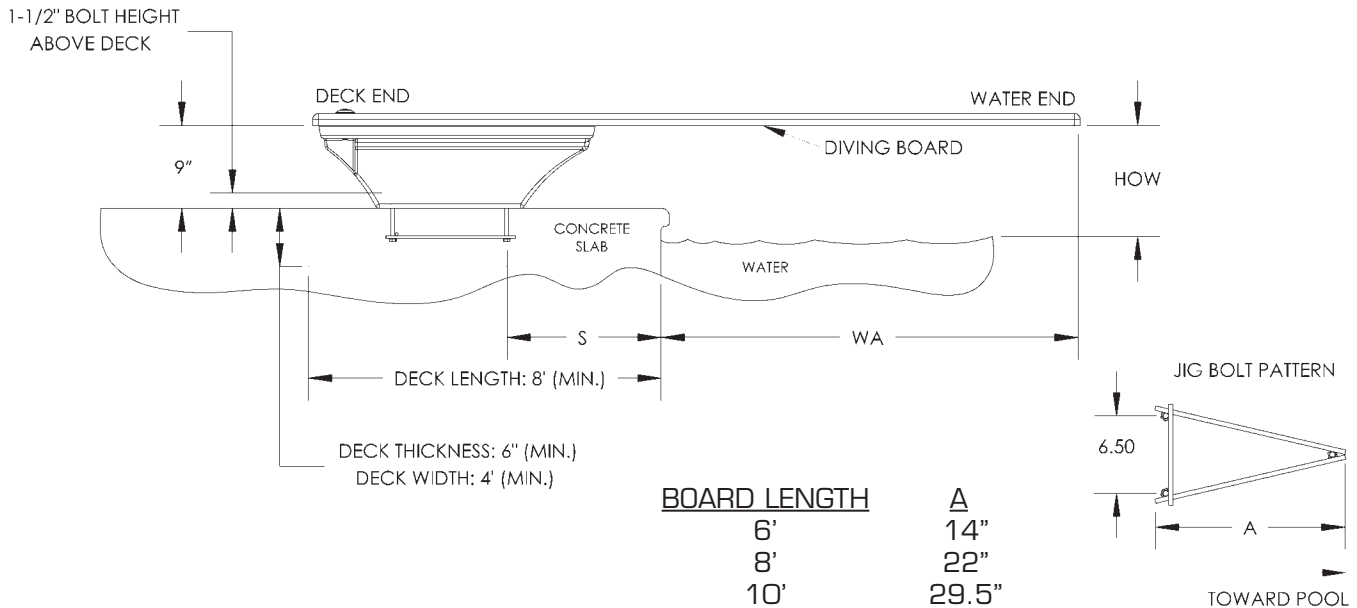

INTER-FAB CANNOT GUARANTEE CUSTOMER'S CONCRETE OR THICKNESS

NOTE: WHEN COPING IS USED, DO NOT SET FRONT JIG BOLTS CLOSER THAN 3" FROM THE BACK EDGE OF THE COPING.

TABLE 3 – PLACEMENT CHART

ADDITIONALLY REFER TO: ANSI/NSPI-5 2003 American National Standard for Residential Inground Swimming Pools and to page 5 for Inter-Fab Residential Inground Pool Minimum Specifications.

IMPORTANT: THESE DIMENSIONS ARE ACCURATE ONLY FOR VERTICAL POOL WALLS, TYPICALLY GUNITE CONSTRUCTION , WITH LESS THAN A 3' RADIUS TO THE POOL FLOOR. DUE TO THE VARYING SIZES OF OTHER POOLS, TYPICALLY VINYL LINER CONSTRUCTION , PLEASE CONTACT CUSTOMER SERVICE FOR PROPER JIG PLACEMENT. 1-800-737-5386	LA MESA PART #	NOMINAL BOARD LENGTH	ANSI/NSPI-5 POOL TYPE	DISTANCE FROM WATER'S EDGE TO FORWARD JIG BOLT (S)	DISTANCE FROM END OF BOARD TO FORWARD JIG BOLT	MIN. OVERHANG PLUS OR MINUS 3" (WA)	MAX HEIGHT OF BOARD ABOVE WATER (HOW)
	LAM6	6'	I	27.5"	45.5"	18"	20"
LAM6	6'	II	27.5"	45.5"	18"	20"	
LAM6	6'	III	21.5"	45.5"	24"	26"	
LAM6	6'	IV	15.5"	45.5"	30"	30"	
LAM6	6'	V	9.5"	45.5"	36"	40"	
LAM8	8'	I	Cannot Put 8' diving board on a type I pool				
LAM8	8'	II	41.25"	59.25"	18"	20"	
LAM8	8'	III	35.25"	59.25"	24"	26"	
LAM8	8'	IV	29.25"	59.25"	30"	30"	
LAM8	8'	V	23.25"	59.25"	36"	40"	
LAM10	10'	I	Cannot Put 10' diving board on a type I pool				
LAM10	10'	II	Cannot Put 10' diving board on a type II pool				
LAM10	10'	III	51.5"	75.5"	24"	26"	
LAM10	10'	IV	45.5"	75.5"	30"	30"	
LAM10	10'	V	39.5"	75.5"	36"	40"	

NOTE: READ THESE INSTRUCTIONS IN THEIR ENTIRETY BEFORE ATTEMPTING THE INSTALLATION.

FIG. B – LOS ARCOS PLACEMENT SPECIFICATIONS:

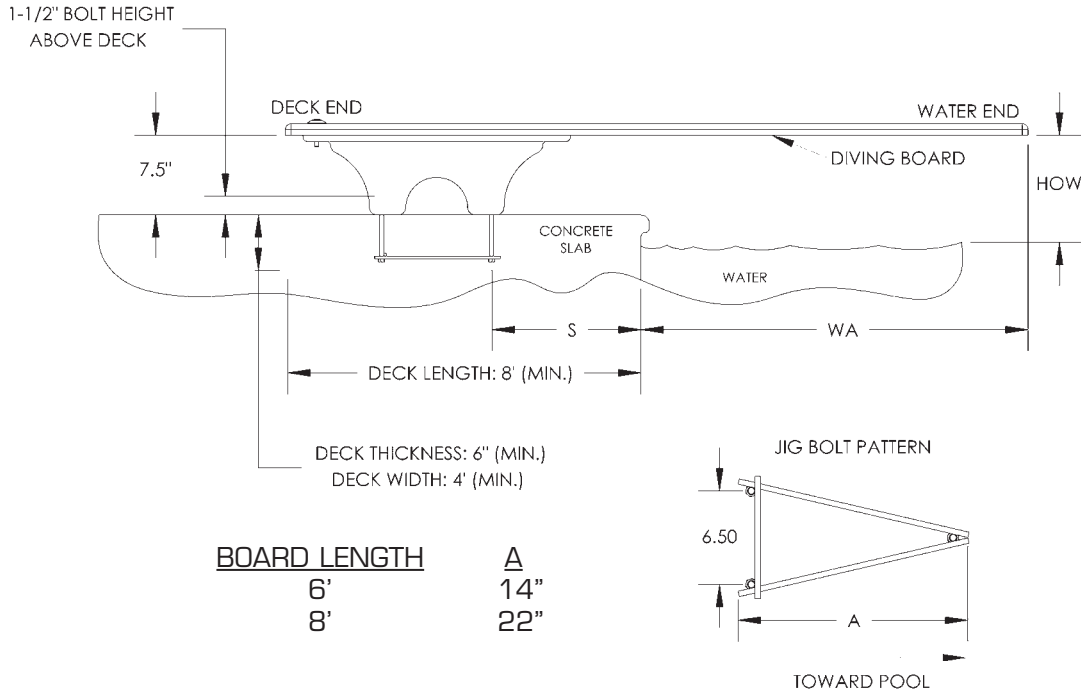

INTER-FAB CANNOT GUARANTEE CUSTOMER'S CONCRETE OR THICKNESS

NOTE: WHEN COPING IS USED, DO NOT SET FRONT JIG BOLTS CLOSER THAN 3" FROM THE BACK EDGE OF THE COPING.

TABLE 4 – PLACEMENT CHART

ADDITIONALLY REFER TO: ANSI/NSPI-5 2003 American National Standard for Residential Inground Swimming Pools and to page 5 for Inter-Fab Residential Inground Pool Minimum Specifications.

IMPORTANT: THESE DIMENSIONS ARE ACCURATE ONLY FOR VERTICAL POOL WALLS, TYPICALLY GUNITE CONSTRUCTION , WITH LESS THAN A 3' RADIUS TO THE POOL FLOOR. DUE TO THE VARYING SIZES OF OTHER POOLS, TYPICALLY VINYL LINER CONSTRUCTION , PLEASE CONTACT CUSTOMER SERVICE FOR PROPER JIG PLACEMENT. 1-800-737-5386	LOS ARCOS PART #	NOMINAL BOARD LENGTH	ANSI/NSPI-5 POOL TYPE	DISTANCE FROM WATER'S EDGE TO FORWARD JIG BOLT (S)	DISTANCE FROM END OF BOARD TO FORWARD JIG BOLT	MIN. OVERHANG PLUS OR MINUS 3" (WA)	MAX HEIGHT OF BOARD ABOVE WATER (HOW)
	LOS6	6'	I	27.5"	45.5"	18"	20"
	LOS6	6'	II	27.5"	45.5"	18"	20"
	LOS6	6'	III	21.5"	45.5"	24"	26"
	LOS6	6'	IV	15.5"	45.5"	30"	30"
	LOS6	6'	V	9.5"	45.5"	36"	40"
	LOS8	8'	I	Cannot Put 8' diving board on a type I pool			
	LOS8	8'	II	41.25"	59.25"	18"	20"
	LOS8	8'	III	35.25"	59.25"	24"	26"
	LOS8	8'	IV	29.25"	59.25"	30"	30"
LOS8	8'	V	23.25"	59.25"	36"	40"	

FIG. C - DURO-BEAM JUMP BOARD

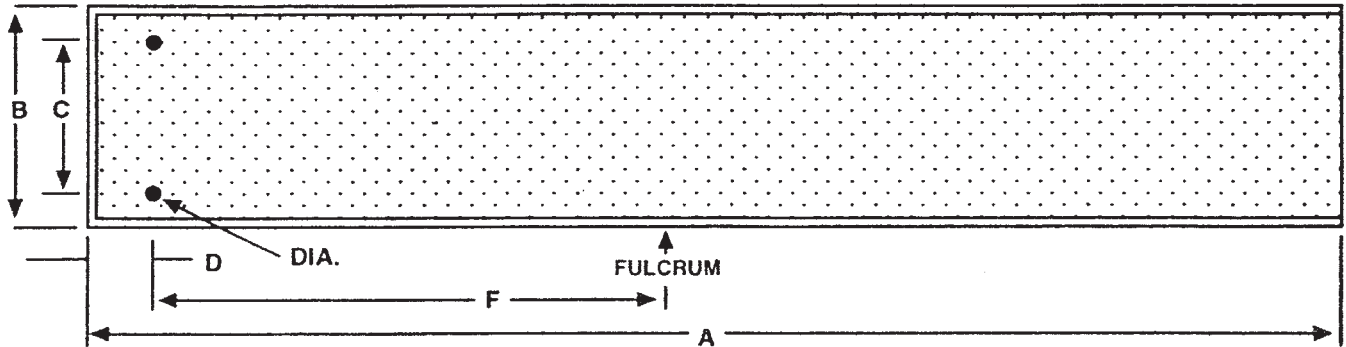

TABLE 5 - BOARD DIMENSIONS AND FULCRUM SETTINGS

Model #	Nominal Length	A	B	C	D	F	DIA.
DB6	6'	70.25"	17.25"	12.00"	4.00"	30.00"	19/32"
DB8	8'	94.00"	17.25"	12.00"	4.00"	40.00"	19/32"
DB10	10' *	117.50"	17.25"	12.00"	4.00"	52.00"	19/32"

* **NOTE:** 10' board not available for Los Arcos stand; 10' board only applicable for the La Mesa stand in accordance with these installation instructions.

FIG. D - LA MESA/LOS ARCOS JIG

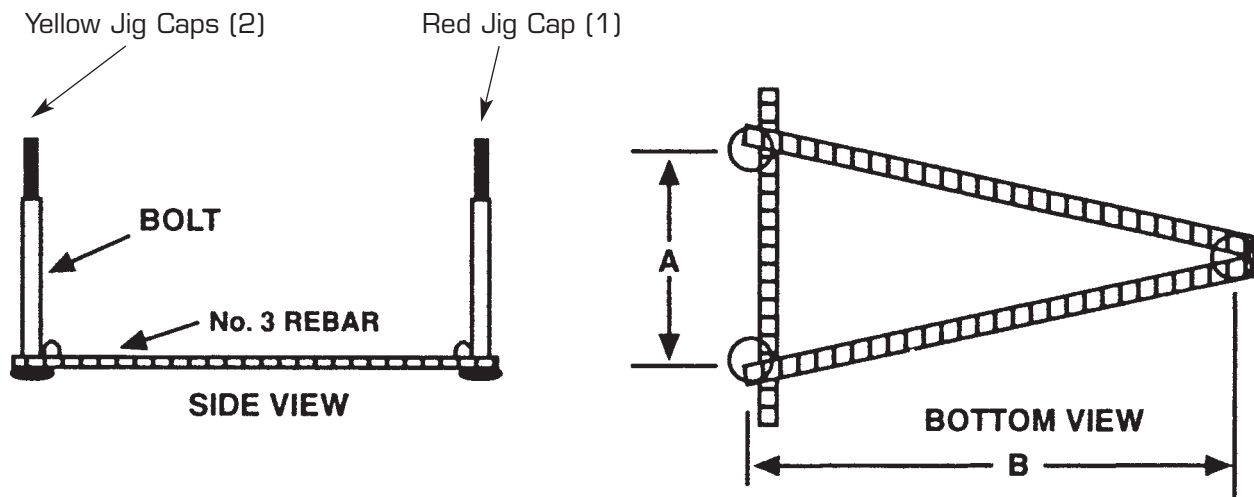

TABLE 6 - JIG DIMENSIONS

Jig Type	A	B	BOLT
6' La Mesa/Los Arcos	6.50"	14.00"	1/2" X 6" Carriage
8' La Mesa/Los Arcos	6.50"	22.00"	1/2" X 6" Carriage
10' La Mesa *	6.50"	29.50"	1/2" X 6" Carriage

* **NOTE:** 10' jig available for La Mesa stand only.

**La Mesa/Los Arcos Stand and/or Duro-Beam Diving Board
INSTALLATION INSTRUCTIONS**

Be sure the concrete deck surrounding the anchor jig complies with the minimum dimensions as shown in Figure A on page 6 for the La Mesa stand, or Figure B on page 7 for the Los Arcos stand.

Read and understand the ANSI/NSPI-5 2003 American National Standard for Residential Inground swimming Pools and Table 1 and Table 2 on page 5 before you install the La Mesa / Los Arcos Stand and/or Duro-Beam Diving Board.

The La Mesa / Los Arcos Stand three-bolt jig should be set in accordance with Table 3 on page 6 (La Mesa stand) or Table 4 on page 7 (Los Arcos stand) with the "RED" capped bolt closest to the pool. The diving board must be placed on the deep end of the pool on centerline.

The tip of the diving board must be positioned directly over Pt. A as shown on the Figures 3 on page 5 and according to the ANSI/NSPI-5 2003 Standard and Inter-Fab's Residential Pool Minimum Specifications

Make sure the jig anchor bolts project out of the concrete deck 1-1/2" with ample concrete depth below the jig in accordance with Figure A on pages 6 (La Mesa stand) or Figure B on page 7 (Los Arcos stand). Do not install the La Mesa / Los Arcos Stand and/or Duro-Beam Diving Board if the deck does not meet the minimum requirements.

When finishing the deck surface, maintain a level deck where the jig bolts project out so the dive stand makes uniform contact with the deck surface. Allow the cement to fully cure before bolting the dive stand to the jig bolts.

Before bolting the dive stand to the jig bolts, chisel away any excess concrete that may have built up around the jig bolts then remove the protective red and yellow rubber bolt caps.

Place the stand over the three jig bolts and secure according to the Hardware Instructions on pages 10-11. Tighten the Stand Anchor Hex Nuts to 40-45 FT- LBS. Do not over tighten.

Once the La Mesa / Los Arcos Stand is properly secured to the three jig bolts, then secure the Diving Board to the Dive Stand according to the Hardware Instructions on page 10-11. Tighten the Board Mounting Hex Nuts to 20-25 FT- LBS. Do not over tighten.

The Diving Board must be installed according the below board leveling instructions:

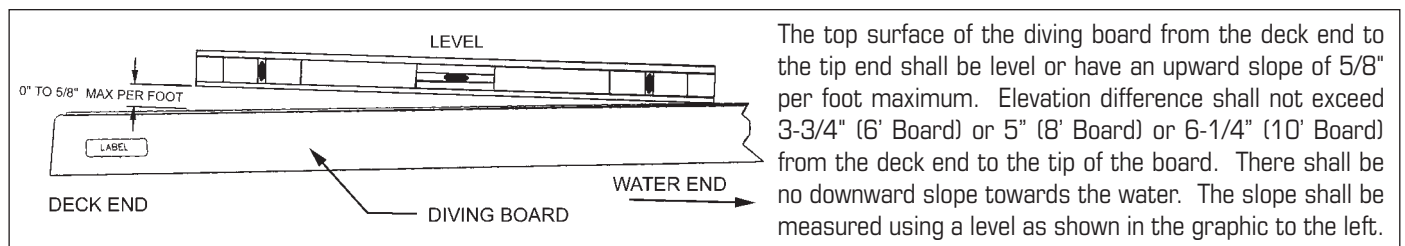

ONLY ONE PERSON ON THE JUMP BOARD AT A TIME, WITH A MAXIMUM WEIGHT OF 250 LBS.

FIG. E - LA MESA BASE EXPLODED VIEW

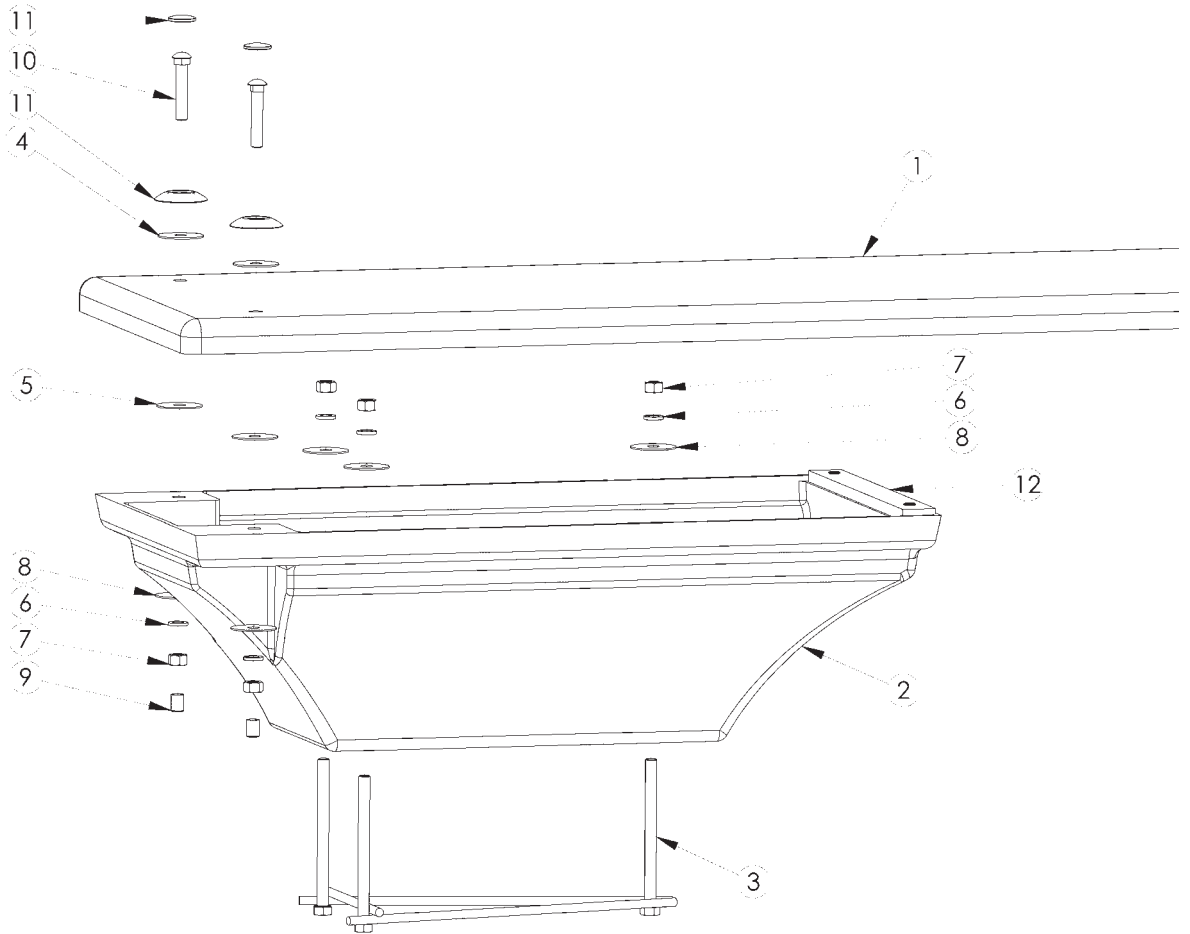

DRAWING REPRESENTS THE FOLLOWING PART NUMBERS:

LAM6 (shown)
LAM8
LAM10

TABLE 8 - PARTS LIST

ITEM #	COMPONENT	DESCRIPTION	KITS - QTY. COUNTS		
			DB-M	LM-BK	N/A
1	DB6WW	6' Duro-Beam White w/White Top Tread & Hdw Kit			1
2	LAM6	6' La Mesa Fiberglass Diving Base			1
3	LM-J6	6' La Mesa/Los Arcos Mounting Jig			1
4	H-1/2 BLK WASH	1/2 x 2" Black Rubber Washer	2		
5	H-1/2 RED WASH	1/2 x 2" Red Rubber Washer	2		
6	H-SS 1/2 LOC WA	1/2 Lock Washer S.S.	2	3	
7	H-SS 1/2 H NUT	1/2"- 13 Hex Finish Nut S.S.	2	3	
8	H-SS 1/2 F WAS	1/2 USS Flat Washer S.S.	2	3	
9	H-1-1/2 WHT CAP	.750 x 1-1/2 White UV Nut Cap	2		
10	H-SS 5 C BOLT	1/2-13 x 5 Carriage Bolt S.S.	2		
11	H-WHT WAS/CAP	I.F. White Washer/Cap	2		
12	LM-FP	La Mesa/Los Arcos Rubber Fulcrum Pad			1

HARDWARE NOTE:

Use a small dab of anti seize lubricant (included) on all bolt threads.

HARDWARE TIGHTENING SCHEDULE:

Secure Stand to Jig with Anchor Hex Nuts at 40-45 FT-LBS

Secure Board to Stand with Mounting Hex Nuts at 20-25 FT-LBS

NOTES:

DB6WW diving board shown in exploded view for illustration purposes. Must be purchased separately. Other diving board options available.

FIG. F - LOS ARCOS BASE EXPLODED VIEW

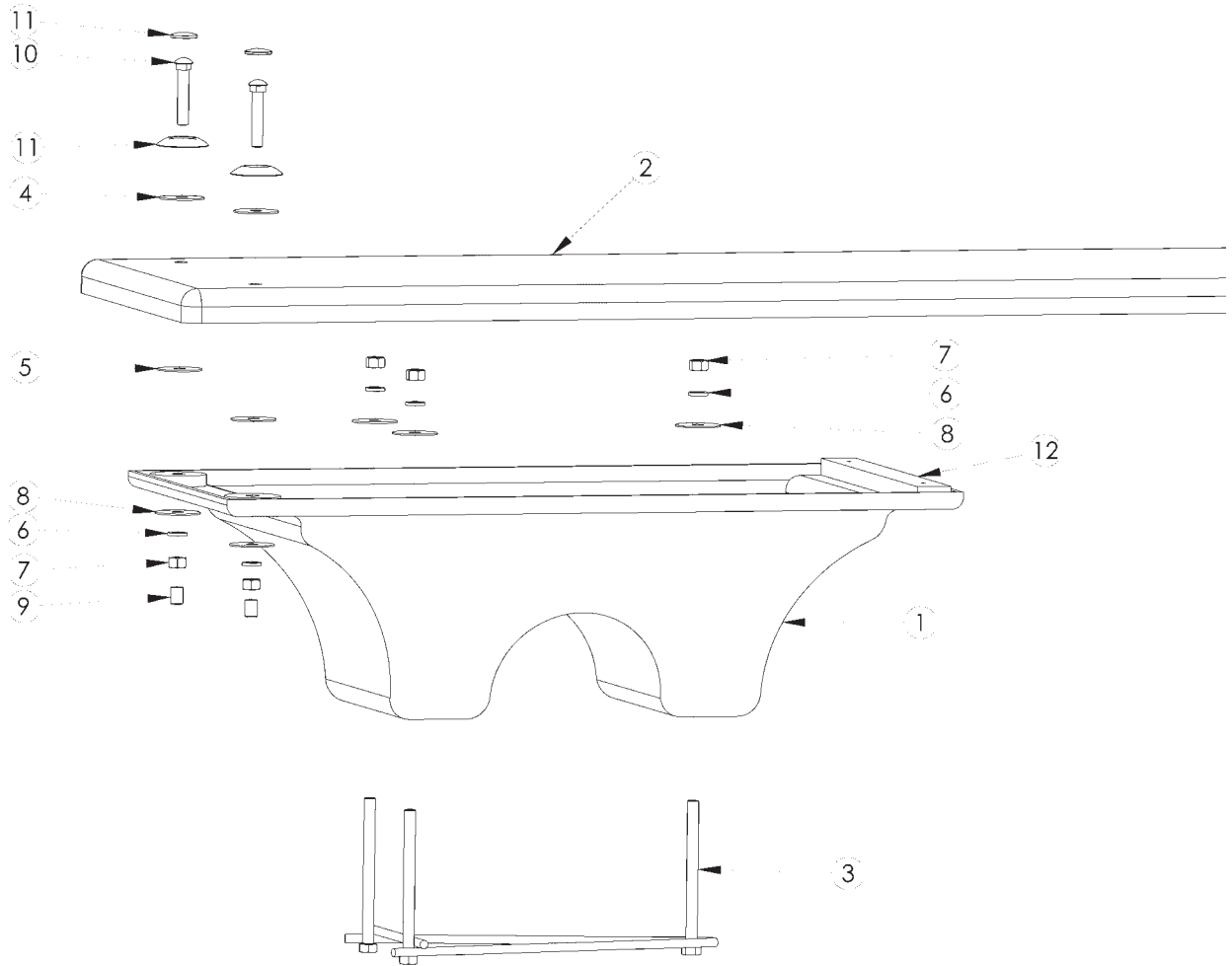

DRAWING REPRESENTS THE FOLLOWING PART NUMBERS:	
	LOS6 (shown)
	LOS8

TABLE 8 - PARTS LIST

ITEM #	COMPONENT	DESCRIPTION	KITS - QTY. COUNTS		
			DB-M	LM-BK	N/A
1	LOS6	6' Los Arcos Fiberglass Diving Base			1
2	DB6WW	6' Duro-Beam White w/White Top Tread & Hdw Kit			1
3	LM-J6	6' La Mesa/Los Arcos Mounting Jig			1
4	H-1/2 BLK WASH	1/2 x 2" Black Rubber Washer	2		
5	H-1/2 RED WASH	1/2 x 2" Red Rubber Washer	2		
6	H-SS 1/2 LOC WA	1/2 Lock Washer S.S.	2	3	
7	H-SS 1/2 H NUT	1/2"- 13 Hex Finish Nut S.S.	2	3	
8	H-SS 1/2 F WASH	1/2 USS Flat Washer S.S.	2	3	
9	H-1-1/2 WHT CAP	.750 x 1-1/2 White UV Nut Cap	2		
10	H-SS 5 C BOLT	1/2-13 x 5 Carriage Bolt S.S.	2		
11	H-WHT WAS/CAP	I.F. White Washer/Cap	2		
12	LM-FP	La Mesa/Los Arcos Rubber Fulcrum Pad			1

HARDWARE NOTE:
Use a small dab of anti seize lubricant (included) on all bolt threads.

HARDWARE TIGHTENING SCHEDULE:

Secure Stand to Jig with Anchor Hex Nuts at 40-45 FT-LBS

Secure Board to Stand with Mounting Hex Nuts at 20-25 FT-LBS

NOTES:

DB6WW diving board shown in exploded view for illustration purposes. Must be purchased separately. Other diving board options available.

PAVER KIT INFO - SELECTED DIVING PRODUCTS

When installing an Inter-Fab diving board and base set up using a paver kit, you must ensure that all standard requirements for a diving board and base installation are met. The diving board and base set up must be compatible with the type of pool on the intended installation and all ANSI/NSPI-2003 requirements must be met.

Figure 1 illustrates the standard minimum concrete pad recommended for all Inter-Fab diving board and base set ups, which is 4' wide x 8' long x 6" deep.

Figure 2 shows an example side view of a paver jig used in a paver installation. Pavers can be a maximum of 3" thick. Pavers must be mechanically attached to the concrete pad using a setting material (such as mortar or thinset for example) that is no thicker than 3/8".

Refer to Figure 3 to determine how much of the jig needs to be exposed above the final deck surface. You will need to factor in the thickness of your paver (3" MAX.) and the thickness of your setting material (3/8" MAX.) for your individual installation.

Inter-Fab Inc. will not be responsible for damage to pavers caused by drilling or mechanically attaching to concrete pad. Refer to paver manufacturer's specific installation instructions before beginning.

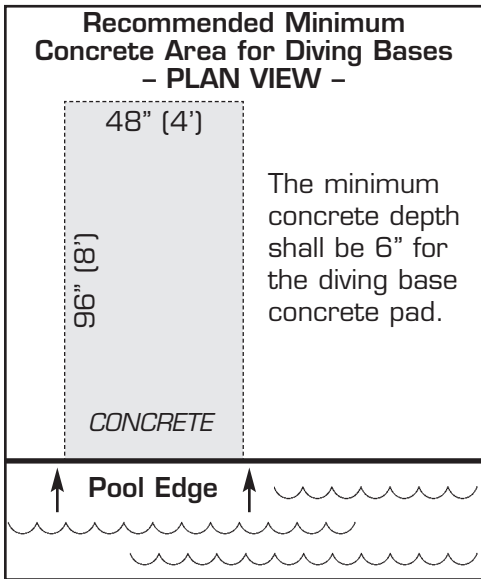

Fig. 1

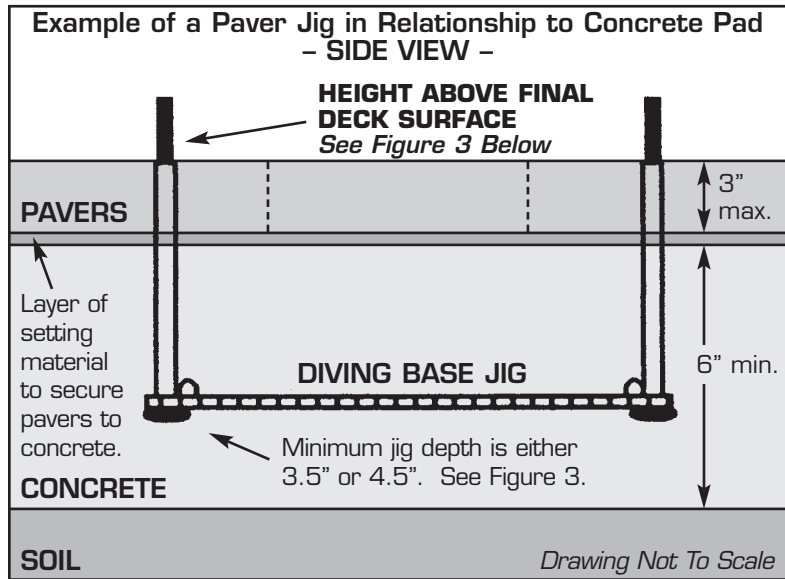

Fig. 2

INTER-FAB DIVING BASE	MIN. JIG DEPTH	PAVER JIG PART NUMBER	PAVER JIG BOLTS	HEIGHT ABOVE FINAL DECK SURFACE
LA MESA BASE / LOS ARCOS BASE	3.5"	LM-J6 PAVER	1/2" X 8" Carriage SS	1.5"
- WITH 8' JIG	3.5"	LM-J8 PAVER	1/2" X 8" Carriage SS	1.5"
- WITH 10' JIG	3.5"	LM-J10 PAVER	1/2" X 8" Carriage SS	1.5"
DURO-SPRING BASE	4.5"	DS-J PAVER	5/8" X 10" Hex Head SS	1.5"
TECHNI-SPRING STEEL BASE	4.5"	TS-J PAVER	1/2" X 10" Hex Head SS	1.5"
TECHNI-SPRING FIBERGLASS BASE	4.5"	TSF-J PAVER	1/2" X 12" Hex Head SS	3.5"
BAJA BASE	4.5"	BA-J6 PAVER	1/2" X 10" Hex Head SS	1.5"
- WITH 8' JIG	4.5"	BA-J8 PAVER	1/2" X 10" Hex Head SS	1.5"
CITY BASE	3.5"	CITY-J6 PAVER	1/2" X 8" Carriage SS	1.5"

Fig. 3

SUPPORT INFORMATION: ARTICLE 5 – POOL DIMENSIONS AND TOLERANCES

Extracted from ANSI/NSPI- 2003, American National Standard for Residential Inground Swimming Pools

5 Pool dimensions and tolerances

5.1 General requirements. Design dimensions shall comply with specifications in this standard. The pool shall be constructed to these design dimensions within the tolerances listed in 5.1.1.

5.1.1 Construction tolerances. There shall be construction tolerances allowed on dimensional designs. The overall length, width and depth shall be limited to a tolerance of plus or minus 3 inches (± 7.6 cm). All other dimensions shall be limited to a tolerance of plus or minus 2 inches (± 5.1 cm), unless otherwise specified.

5.2 Perimeter shape. No limits are specified for shape of pools except that consideration shall be given to shape from the standpoint of circulation of the swimming pool water and safety to the user.

5.3 Walls - requirements

5.3.1 Walls in the shallow area and deep area of the pool shall not slope greater than 11° (1:5 slope

ratio) to a transition point. The transition point shall not be less than 2 feet and 9 inches (83.8 cm) below the waterline. See figure 1.

5.3.2 As shown in figure 2, at the depths of (a) and (b), the walls are permitted to join the floor.

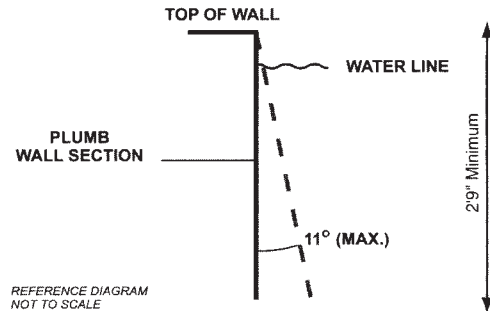

Figure 1 – Maximum allowable wall slope

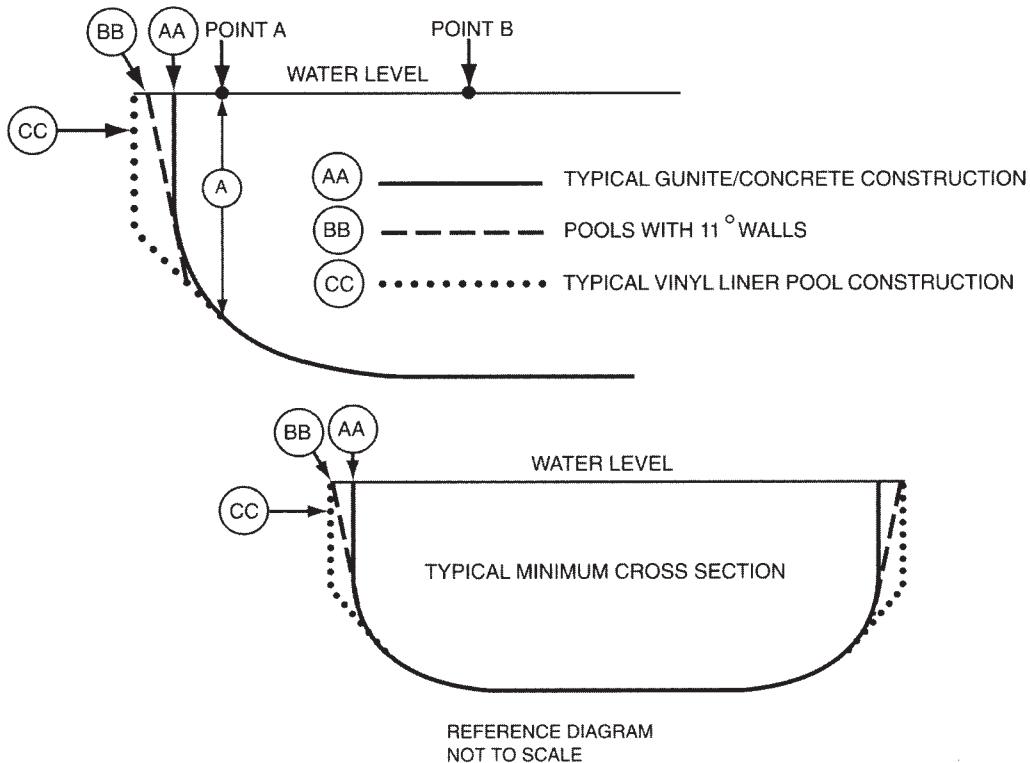

Figure 2 – Typical pool design configurations

SUPPORT INFORMATION: ARTICLE 5 – POOL DIMENSIONS AND TOLERANCES

Extracted from ANSI/NSPI- 2003, American National Standard for Residential Inground Swimming Pools

5.3.3 The walls of Type I pool, when defining the minimum diving water envelope, shall be plumb or outside of Type 1 water geometry. (See figure 3, table 1.)

5.4 Maximum allowable wall slope

5.4.1 Maximum allowable wall slope shall not slope greater than 11° from plumb.

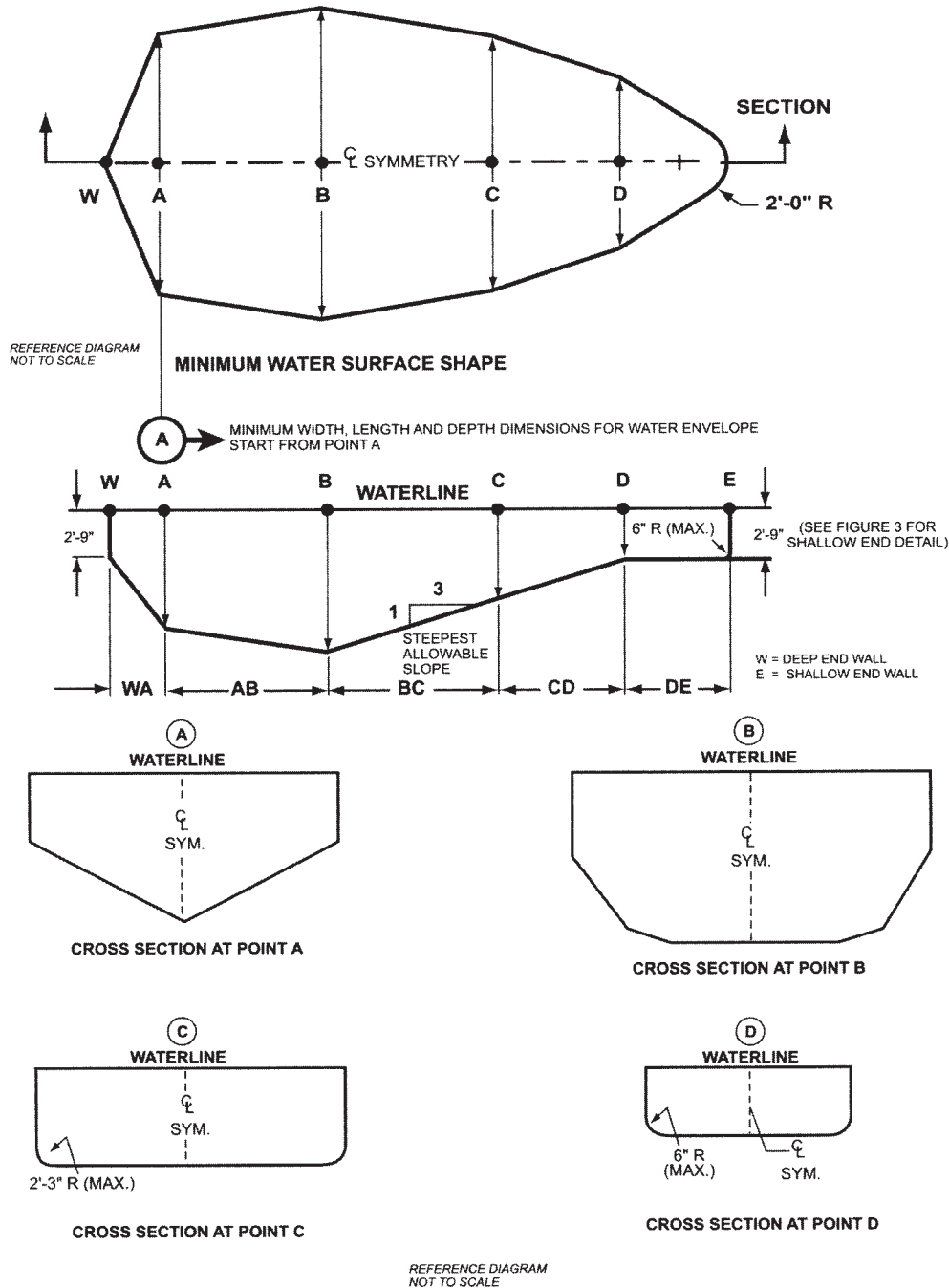

Figure 3 – Minimum water envelope

SUPPORT INFORMATION: ARTICLE 5 – POOL DIMENSIONS AND TOLERANCES

Extracted from ANSI/NSPI- 2003, American National Standard for Residential Inground Swimming Pools

Table 1 – Minimum water envelope

Pool type	Minimum depths at point				Minimum widths at point				Minimum lengths between points					
	A	B	C	D	A	B	C	D	WA	AB	BC	CD*	DE	WE
O	Manufactured diving equipment is prohibited													
I	6'-0"	7'-6"	5'-0"	2'-9"	10'-0"	12'-0"	10'-0"	8'-0"	1'-6"	7'-0"	7'-6"	Varies	6'-0"	28'-9"
II	6'-0"	7'-6"	5'-0"	2'-9"	12'-0"	15'-0"	12'-0"	8'-0"	1'-6"	7'-0"	7'-6"	Varies	6'-0"	28'-9"
III	6'-10"	8'-0"	5'-0"	2'-9"	12'-0"	15'-0"	12'-0"	8'-0"	2'-0"	7'-6"	9'-0"	Varies	6'-0"	31'-3"
IV	7'-8"	8'-6"	5'-0"	2'-9"	15'-0"	18'-0"	15'-0"	9'-0"	2'-6"	8'-0"	10'-6"	Varies	6'-0"	33'-9"
V	8'-6"	9'-0"	5'-0"	2'-9"	15'-0"	18'-0"	15'-0"	9'-0"	3'-0"	9'-0"	12'-0"	Varies	6'-0"	36'-9"

NOTE:

- *Minimum length between points CD may vary based upon water depth at point D and the slope between points C & D.
- Figure 3 drawings are not to scale. (For pool types, see Glossary.)

5.5 Offset ledges

5.5.1 Offset ledges shall be a maximum of 8 inches (20.3 cm) wide.

5.5.1.1 Offset ledges, located less than 42 inches (1067 mm) below waterline shall be proportionately less than 8 inches (20.3 cm) wide and fall within 11° from plumb, measured from the top of the waterline. See figure 4.

5.6 Floor slopes. Floor slopes shall be reasonably uniform and comply with 5.6.1 through 5.6.3.

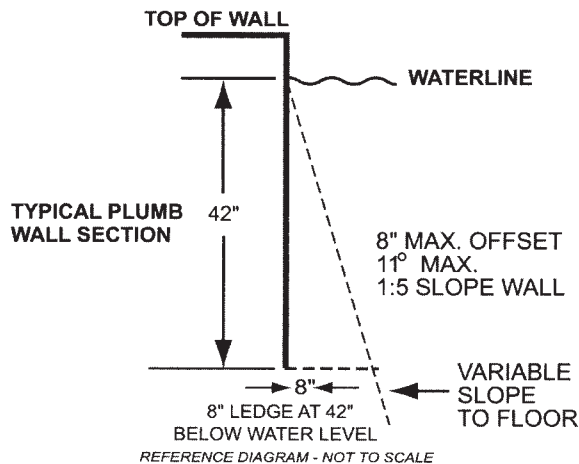

Figure 4 – Offset ledges

5.6.1 The slope of the floor from the shallow end wall towards the deep area shall not exceed 1 foot in 7 feet (30 cm: 213 cm) to the point of the first slope change as shown in figure 5.

5.6.2 Changes in slope between shallow and deep areas shall be at a minimum water depth of 2 feet 9 inches (83.8 cm) and be at least six feet (182.9 cm) from the shallow end, except as specified in 6.3.

5.6.3 The slope of the floor from the point of the first slope change toward the deep end shall not exceed 1 foot in 3 feet (30 cm: 91 cm).

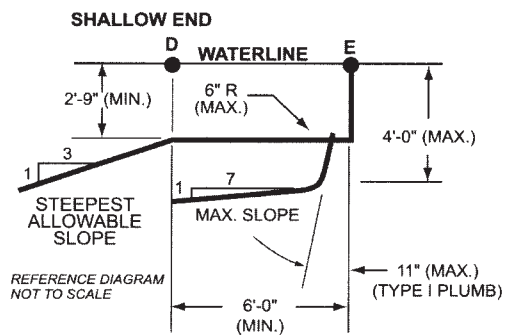

Figure 5 – Shallow end depths

SUPPORT INFORMATION: ARTICLE 5 – POOL DIMENSIONS AND TOLERANCES

Extracted from ANSI/NSPI- 2003, American National Standard for Residential Inground Swimming Pools

5.7 Shallow end water depths. Water depth in the shallow area shall be a minimum of 2 feet 9 inches (83.8 cm) except for those locations specified in 6.3 "Shallow End Detail for Beach and Sloping Entries." The water depth at the shallowest point shall not exceed four feet (121.9 cm) as shown in figure 5.

5.8 Manufactured diving equipment for in-ground swimming pools (diving board/stand combination or manufactured platform)

NOTE – For consumer safety information, warnings and education programs, See appendices D, E, and F.

5.8.1 When manufactured diving equipment is installed, it shall conform to the specifications set forth in 5.8 through 5.9 and shall be located in the deep area of the pool so as to provide the minimum dimensions as shown in 5.9.

5.8.1.1 Manufactured diving equipment shall not be installed on Type 0 pools.

5.8.2 Diving equipment. Diving equipment shall be designed for swimming pool use and shall be installed in accordance with the manufacturer's specifications.

5.8.2.1 Diving equipment installation and use instructions shall be provided by the diving equipment manufacturer and shall specify the minimum water dimensions required for each diving board and diving stand combination. They may refer to the water envelopes type of their choice by dimensionally relating their products to Point A on the water envelopes as shown in figure 3 and table 1, 5.9.1 through 5.9.3.

5.8.2.2 Diving equipment shall be permanently labeled and affixed to the diving equipment or jump boards and shall include but not be limited to:

- manufacturer's name and address;
- date of manufacture;
- minimum water envelope required for each diving board and diving stand combination; and
- maximum weight limitations of the user as specified by the board manufacturer.

5.8.2.3 Diving equipment shall have slip-resisting tread surfaces.

5.9 Figure 3 contains suggested drawings and diagrams for minimum water envelope for swimming pools designated type I - V. Individual pool types are shown in figure 3 and table 1.

5.9.1 Location of point A. Point A shall be defined as a point located on the minimum water envelopes.

5.9.1.1 Point A. Point A is a construction location nearest the deep end wall where the minimum water depth is satisfied.

5.9.1.2 Point A as shown in figure 3 and table 1 shall be the reference point of origin for all dimensions defining the minimum water envelope.

5.9.2 Type 0 pool (where diving is prohibited) shall not be limited in width, length, or water depth except as specifically provided for in this standard.

5.9.3 Location of equipment and pool features in the minimum water envelope. If the pool is designed for use with diving equipment, steps, pool stairs, ladders, underwater benches, special features and other accessory items shall be located outside the minimum water envelope. (See figure 6)

5.9.4 Typical pool design configurations. Vinyl liner, shotcrete, fiberglass and concrete constructions shall conform to, but are not limited to, the typical pool configurations shown in figure 2.

5.10 Stationary diving platform(s) and diving rock(s). Stationary diving platform(s) and diving rock(s) built on site shall be allowed to be flush with the wall and located in the diving area of the pool. Point A shall be in front of the wall at the platform or diving rock centerline.

NOTE – For consumer safety information, warning, and education programs, See appendices D, E, and F.

SUPPORT INFORMATION: ARTICLE 5 - POOL DIMENSIONS AND TOLERANCES

Extracted from ANSI/NSPI- 2003, American National Standard for Residential Inground Swimming Pools

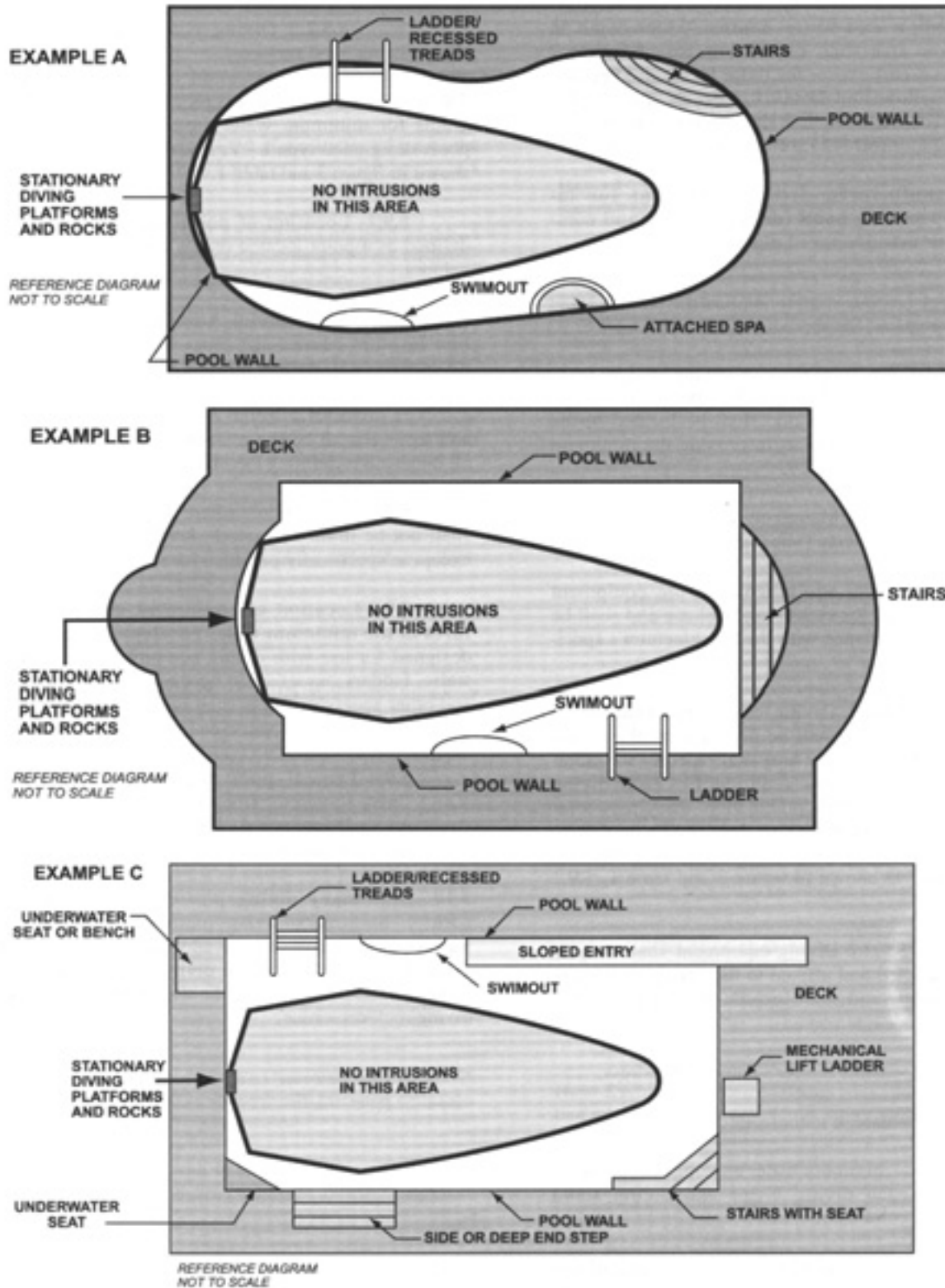

Figure 6 – Top view examples of accessory equipment and pool features prohibited in the water envelope

SUPPORT INFORMATION: ARTICLE 5 – POOL DIMENSIONS AND TOLERANCES

Extracted from ANSI/NSPI- 2003, American National Standard for Residential Inground Swimming Pools

5.10.1 The maximum height of the stationary diving platform or diving rock above the waterline shall be as follows:

- Pool Type I 42 inches (106.7 cm);
- Pool Type II 42 inches (106.7 cm);
- Pool Type III 50 inches (127.0 cm);
- Pool Type IV 60 inches (152.4 cm); or
- Pool Type V 69 inches (175.3 cm)

5.10.2 Stationary diving platform(s) and diving rock(s) shall not be permitted on Pool Type 0.

5.10.3 The diving equipment manufacturer shall specify minimum headroom above water.

5.11 Swimming pool slides

5.11.1 Slides, where installed, shall be installed in accordance with manufacturer's specifications.

NOTE – For consumer safety information, warnings, and education programs, see appendices D, E, and F.

To obtain complete copies of the ANSI/NSPI-5 2003 Standard for Residential Inground Pools contact:

**The Association of Pool & Spa Professionals (APSP)
2111 Eisenhower Ave.
Alexandria, VA 22314
(703) 838-0083**

or visit: www.theapsp.org

LIMITED WARRANTY

Inter-Fab, Inc. will repair or replace, at its option, any product manufactured by Inter-Fab, Inc. that fails during the applicable warranty period because of a manufacturing or material defect; provided that the defect is not the result of improper installation, improper use or care, negligence, alterations or modifications to the product, or natural accidents (acts of God). The applicable warranty period for products manufactured by Inter-Fab, Inc. is three (3) years from the date of retail purchase, except as specified below:

Echoes of Nature™ products are individually handcrafted and painted by skilled artisans and as a result, dimensional differences and color variations are normal and are not a basis for warranty coverage. The warranty period for pumps sold with the Echoes of Nature™ products is three (3) years from the date of retail purchase.

Water Sports™ sports equipment warranty periods are as follows: Volleyball Poles, Basketball Poles, Basketball Rim, and Basketball Backboard are one (1) year from date of retail purchase. Volleyball, Volleyball Net, Basketball, Basketball Net, and pumps are warranted for ninety (90) days from date of retail purchase.

Splash Rock™ Edgewater, **T7™** Edgewater™ and **Lighted Edgewater™** features warranty period is one (1) year from date of retail purchase.

Zoomerang™ slide products warranty period is one (1) year from the date of retail purchase.

Build Your Own Slide™ (BYOS™) warranty period is one (1) year from the date of retail purchase.

City 2™ Slide and **City Base™** products warranty period are one (1) year from the date of retail purchase.

Unless expressly stated otherwise all products manufactured by Inter-Fab are for **residential installation (single family residence)** inground pool use only. Inter-Fab, Inc. expressly disclaims any and all warranties and liability arising from the installation or use of its residential products for any non-residential use such as semi-public, public, or commercial applications. Products expressly manufactured for commercial installation and use will be subject to this limited warranty.

This limited warranty is in lieu of all other warranties, whether express or implied. Inter-Fab, Inc. disclaims any warranty of merchantability or fitness for a particular use, and noninfringement in relation to any of its products and Inter-Fab, Inc. is not liable for consequential, incidental or specific damages. This warranty is limited to the repair or replacement of the manufacturing or material defect, or refund of the original purchase price, whichever is less, at the sole option of Inter-Fab, Inc., and expressly does not cover any labor or reinstallation expenses related to the replacement of any and all Inter-Fab products. This limited warranty shall be the sole and exclusive remedy of irrespective of whether the claims are made in contract, tort, warranty, law, equity or by statute.

This warranty is to the original purchaser of the product only. Inter-Fab's limited warranty is neither transferable nor portable from consumer to consumer. The effective coverage date begins at the date of retail purchase. Product owner or representative must notify Inter-Fab, Inc. (or its wholesale agent) in writing, giving a full description of the nature of the product defect or failure along with proof of purchase, serial number(s) of the product and photos within thirty (30) days of the expiration of the applicable warranty period. Inter-Fab, Inc. reserves the right to physically inspect damaged or defective products or components to determine the cause of the damage or defect, prior to authorizing repair or replacement of its products.



3050 S. Alvernon Way • Tucson, AZ 85713

520.790.7040 • 800.737.5386 • Fax 520.790.7127 • inter-fab.com