

INFERNO 20-IN-1 MULTI-GAME TABLE ASSEMBLY INSTRUCTIONS



NG1017M3











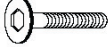







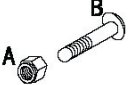

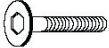
THANK YOU!

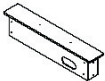
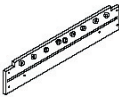
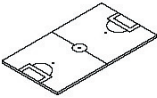
Thank you for purchasing this product.

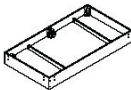



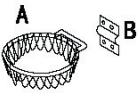
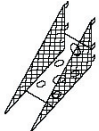





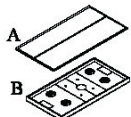
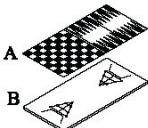
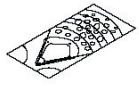

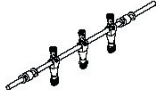
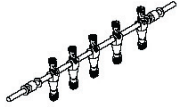
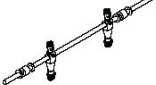
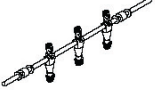
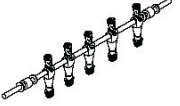
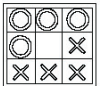

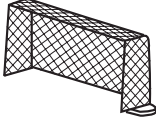



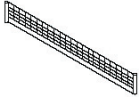

We work around the clock and around the globe to ensure that our products maintain the highest possible quality. However, in the rare instance that your product is defective or missing parts, contact your retailer, or call 800-759-0977, to submit parts requests or warranty claims. Please read the warranty information at the back of these assembly instructions for further details.

IMPORTANT! PLEASE READ THESE ASSEMBLY INSTRUCTIONS IN ENTIRETY BEFORE ASSEMBLING YOUR PRODUCT.



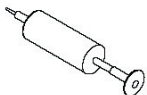

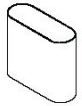









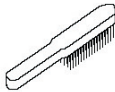

PARTS IDENTIFIER (NOT TO SCALE)

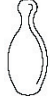
<p>#1</p>  <p>1-3/4" ROUND SCREW 6 pcs</p>	<p>#2</p>  <p>1-1/8" BOLT 20 pcs</p>	<p>#3</p>  <p>1-1/2" WING BOLT 4 pcs</p>	<p>#4</p>  <p>3/4" BOLT 2 pcs</p>	<p>#5</p>  <p>5/16" FLAT WASHER 20 pcs</p>
<p>#6</p>  <p>1-3/4" FLAT SCREW 8 pcs</p>	<p>#7</p>  <p>5/8" SCREW 4 pcs</p>	<p>#8</p>  <p>1" FLAT SCREW 4 pcs</p>	<p>#9</p>  <p>LEG LEVELER 4 pcs</p>	<p>#10</p>  <p>5/32" NUT & BOLT 4 pcs</p>
<p>#11</p>  <p>HEX WRENCH 1 pc</p>	<p>#12</p>  <p>BASKETBALL ARM 2 pcs</p>			<p>#15</p>  <p>1" BOLT 4 pcs</p>
<p>#16</p>  <p>1/4" FLAT WASHER 4 pcs</p>	<p>#17</p>  <p>END PANEL 2 pcs</p>	<p>#18</p>  <p>SIDE PANEL 2 pcs</p>	<p>#19</p>  <p>SOCCER PLAYFIELD 1 pc</p>	<p>#20</p>  <p>PLAYFIELD SUPPORT BRACE 3 pcs</p>
<p>#21</p>  <p>CORNER 4 pcs</p>	<p>#22</p>  <p>BILLIARD TABLE BODY 1 pc</p>	<p>#23</p>  <p>RIGHT LEG 2 pcs</p>	<p>#24</p>  <p>LEFT LEG 2 pcs</p>	<p>#25</p>  <p>LEG PANEL 2 pcs</p>
<p>#26</p>  <p>BASKETBALL BACKBOARD 1 pc</p>	<p>#27</p>  <p>BASKETBALL RIM 1 pc</p>	<p>#28</p>  <p>BASKETBALL SIDE NET 1 pc</p>	<p>#29</p>  <p>HAND GRIP 8 pcs</p>	<p>#30</p>  <p>ROD END CAP 8 pcs</p>

PARTS IDENTIFIER (NOT TO SCALE)

<p>#31</p>  <p>MANUAL SCORER 2 pcs</p>	<p>#32</p>  <p>TABLE TENNIS/ HOCKEY PLAYFIELD 1 pc</p>	<p>#33</p>  <p>GAME BOARD 1 pc</p>	<p>#34</p>  <p>BASEBALL/ FOOTBALL PLAYFIELD 1 pc</p>	<p>#35</p>  <p>2 AWAY PLAYERS ROD 1 pc</p>
<p>#36</p>  <p>3 AWAY PLAYERS ROD 2 pcs</p>	<p>#37</p>  <p>5 AWAY PLAYERS ROD 1 pc</p>	<p>#38</p>  <p>2 HOME PLAYERS ROD 1 pc</p>	<p>#39</p>  <p>3 HOME PLAYERS ROD 2 pcs</p>	<p>#40</p>  <p>5 HOME PLAYERS ROD 1 pc</p>
<p>#41</p>  <p>TIC TAC TOE 1 SET</p>	<p>#42</p>  <p>STRIKER 2 pcs</p>	<p>#43</p>  <p>PUCK 2 pcs</p>	<p>#44</p>  <p>HOCKEY GOAL 1 SET</p>	<p>#45</p>  <p>HOCKEY STICK 2 pcs</p>
<p>#46</p>  <p>BEAN BAGS 1 SET</p>	<p>#47</p>  <p>FOOTBALL 1 pc</p>	<p>#48</p>  <p>PLAYING CARDS 1 SET</p>	<p>#49</p>  <p>SOCCER BALL 2 pcs</p>	<p>#50</p>  <p>TABLE TENNIS PADDLE 2 pcs</p>
<p>#51</p>  <p>TABLE TENNIS BALL 2 pcs</p>	<p>#52</p>  <p>TABLE TENNIS NET 1 pc</p>	<p>#53</p>  <p>TABLE TENNIS NET POST 2 pcs</p>	<p>#54</p>  <p>FOOTBALL GOAL POST 1 pc</p>	<p>#55</p>  <p>FINGER FOOTBALL 4 pcs</p>
<p>#56</p>  <p>BASKETBALL 1 pc</p>	<p>#57</p>  <p>AIR PUMP 1 pc</p>	<p>#58</p>  <p>DICE 1 SET</p>	<p>#59</p>  <p>DICE CUP 1 pc</p>	<p>#60</p>  <p>CHESS 1 SET</p>

PARTS IDENTIFIER (NOT TO SCALE)

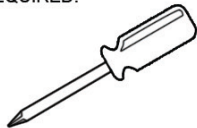
<p>#61</p>  <p>CHECKERS 1 SET</p>	<p>#62</p>  <p>BASEBALL 1 SET</p>	<p>#63</p>  <p>BASEBALL BAT 2 pcs</p>	<p>#64</p>  <p>BASEBALL MARKER 1 SET</p>	<p>#65</p>  <p>CHALK 2 pcs</p>
<p>#66</p>  <p>BILLIARD BALLS 1 SET</p>	<p>#67</p>  <p>BRUSH 1 pc</p>	<p>#68</p>  <p>CUE STICK 2 pcs</p>	<p>#69</p>  <p>TRIANGLE 1 pc</p>	<p>#70</p>  <p>BOWLING PINS 1 SET</p>
<p>#71</p>  <p>BOWLING BALL 1 pc</p>	<p>#72</p>  <p>SHUFFLEBOARD PUCKS 1 SET</p>	<p>#73</p>  <p>HORSESHOES 1 SET</p>	<p>#74</p>  <p>RING TOSS 1 SET</p>	<p>#75</p>  <p>RING TOSS POST 1 pc</p>
<p>#76</p>  <p>FOAM BUMPER 16 pcs</p>	<p>#77</p>  <p>PLASTIC ROD WASHER 16 pcs</p>			
<p>ADDITIONAL EQUIPMENT REQUIRED:</p>  <p>PHILLIPS HEAD SCREWDRIVER</p>				

*Please see Parts List at end of manual for part number when ordering parts.
For replacement parts please call 800-759-0977.*

ASSEMBLY TIPS

1. Find a clean, level surface to begin the assembly of your game table. The table will be partially assembled upside down and then turned over onto its legs. This is a heavy game and turning it over will require at least two strong adults.
2. Remove all of the contents from box and verify that you have all of the parts shown on the Parts Identifier before you begin assembly. **Note: Some parts may be pre-installed or pre-assembled.**
3. Some figures or drawings may not look exactly like your product. Please read and understand the text before beginning each assembly step.
4. **When installing parts that have more than one screw or bolt, hand tighten all screws or bolts in place before final tightening with screwdriver or hex wrench.**
5. Electric screwdrivers may be helpful during assembly; however, please set a **low torque** and use extreme caution because screws may be stripped or overtightened, resulting in damaged parts, if the electric screwdriver's torque is set too high.

WARNINGS!

READ AND FOLLOW ALL ASSEMBLY, OPERATION AND SAFETY INSTRUCTIONS CAREFULLY.

**CHOKER HAZARD - THIS TABLE CONTAINS SMALL BALLS AND PARTS
NOT SUITABLE FOR CHILDREN UNDER 3 YEARS OF AGE.**

ASSEMBLY INSTRUCTIONS

1. To assemble SOCCER TABLE, insert pre-assembled AWAY PLAYER RODS #35, 36 and 37 and HOME PLAYER RODS #38, 39 and 40 into one SIDE PANEL #18 as shown below. *Note: You may choose either color for home or away teams. Each team should face the opposite goal when table is turned over - the visible screw head indicates the front of the player. Ensure that the FOAM BUMPERS #76 and PLASTIC ROD WASHERS #77 are in place before inserting rods into the SIDE PANELS.*

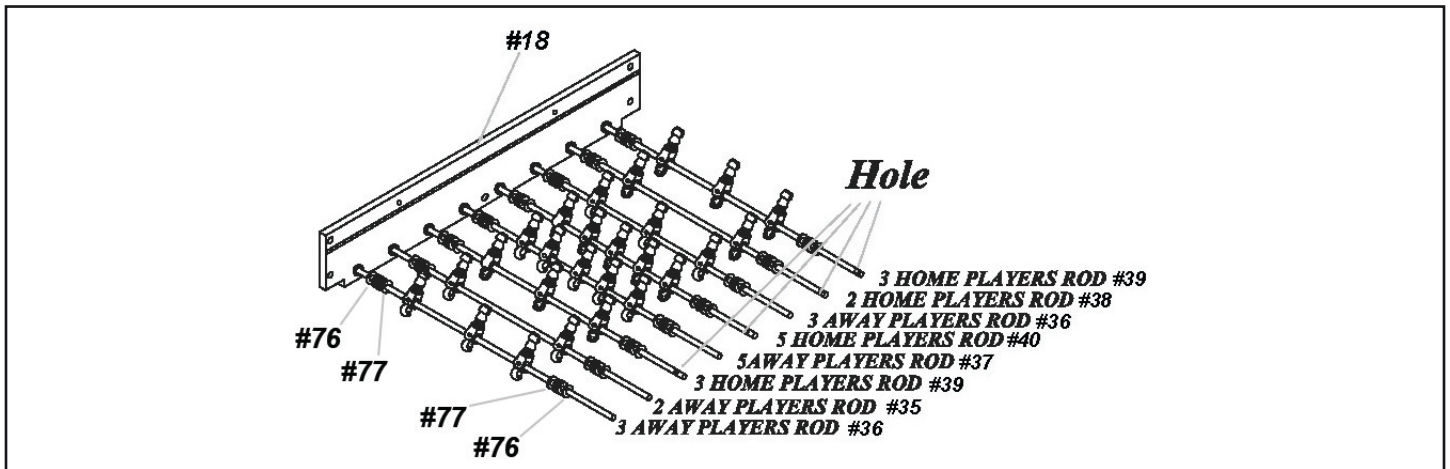

2. Insert PLAYER RODS into remaining SIDE PANEL #18.

3. Attach one END PANEL #17 to SIDE PANELS #18 with 1-3/4" FLAT SCREWS #6.
Note: Finger tighten screws into pre-drilled holes before tightening with tool.

4. Slide SOCCER PLAYFIELD #19 with field markings facing down into the SIDE PANEL grooves.
Note: The table is assembled upside down.

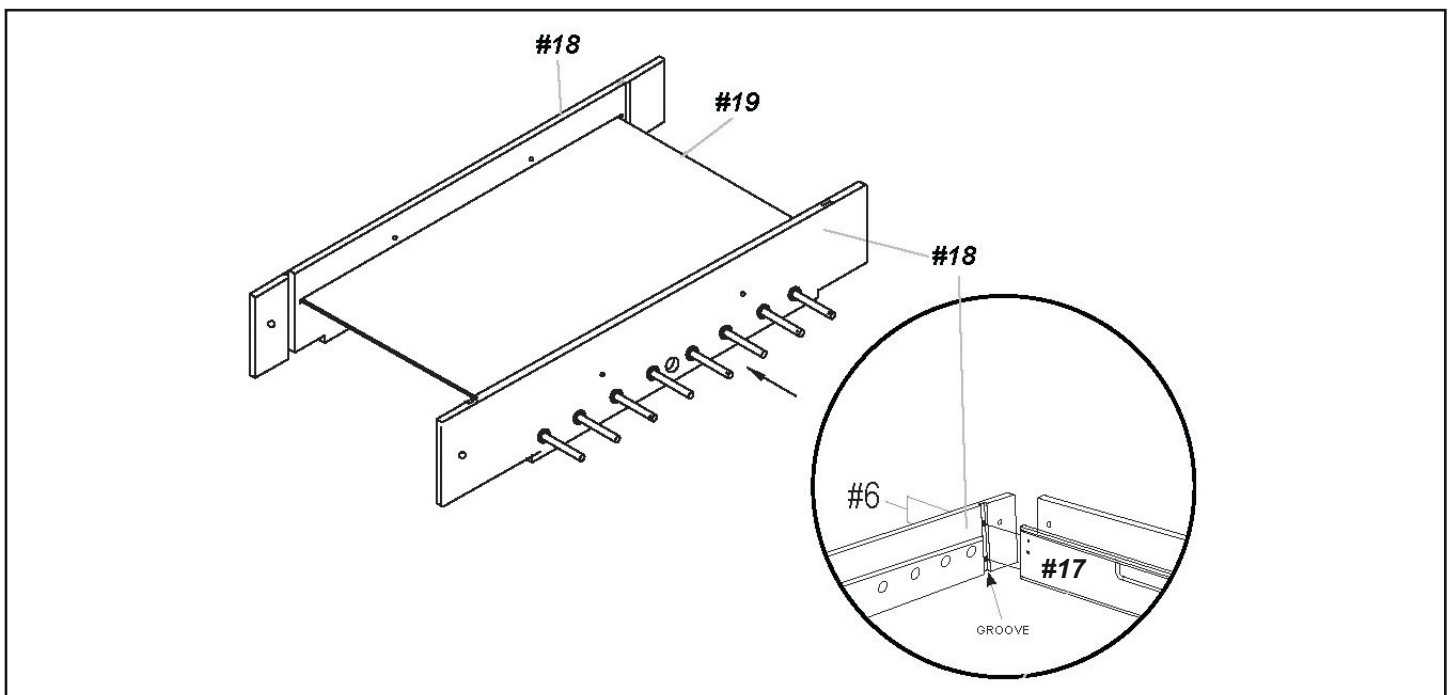

ASSEMBLY INSTRUCTIONS (CONT.)

5. Attach other END PANEL #17 with 1-3/4" FLAT SREWS #6. *Note: It may help to have a second person guide PLAYFIELD into SIDE & END PANELS. Also, it may help to carefully stand up the assembled SIDES on attached END PANEL to slide PLAYFIELD into grooves.*
6. Attach one CORNER #21 to each corner of the table with 1-1/8" BOLT #2 and 5/16" FLAT WASHER #5. *Note: wider end of CORNER is positioned up from bottom of PLAYFIELD. Don't forget, the table is assembled upside down.*
7. Attach each PLAYFIELD SUPPORT BRACE #20 underneath SOCCER PLAYFIELD as shown by fastening to SIDE PANELS with 1-3/4" ROUND SCREW #1.

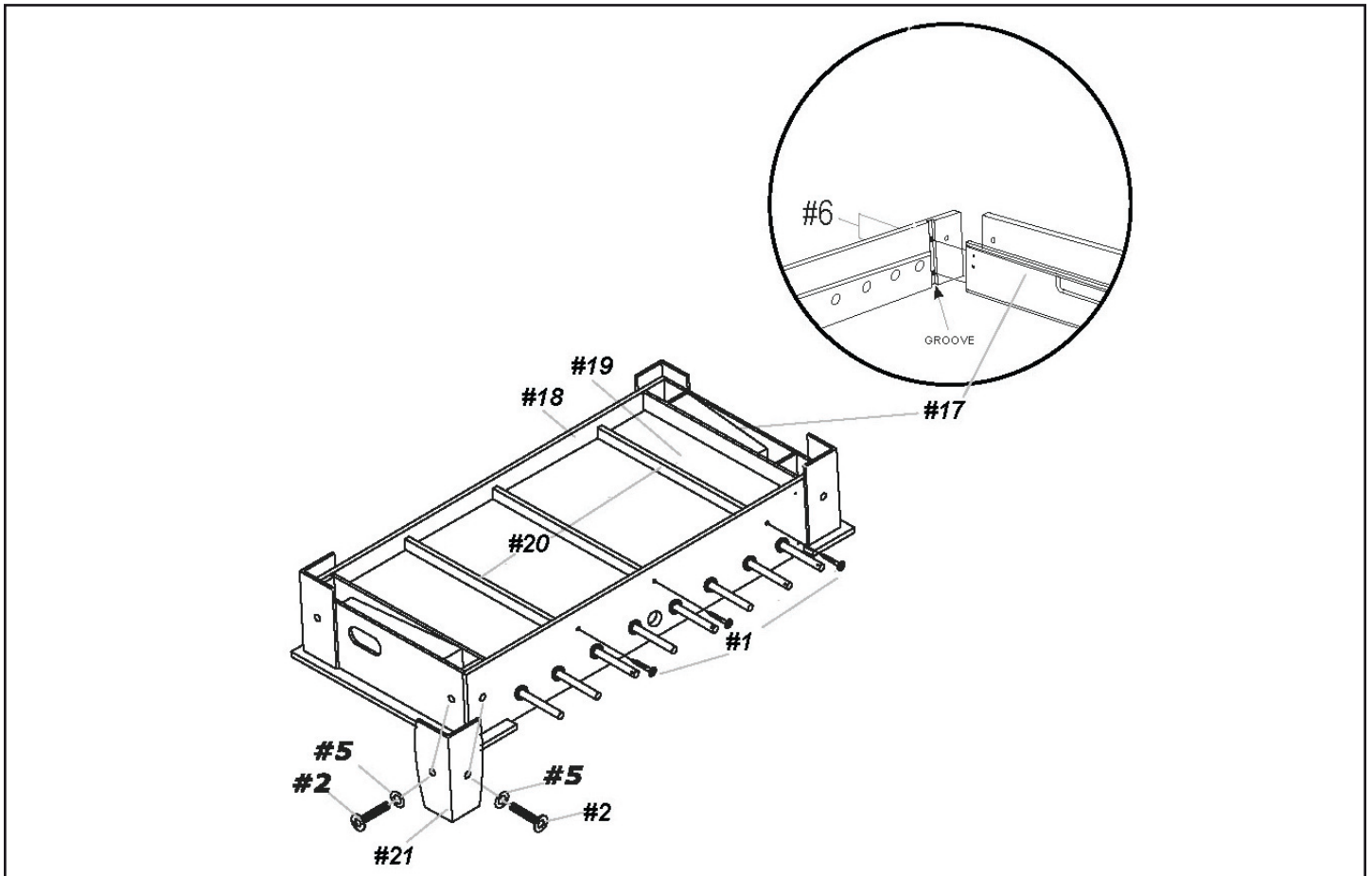

8. Carefully turn SOCCER TABLE over. Attach one MANUAL SCORER #31 to each end of the table with 1" FLAT SCREW #8. *Note: Cut and remove rubber bands holding parts together, if present.*
9. Attach one HAND GRIP #29 to the marked end of each PLAYER ROD. Attach ROD END CAP #30 to the opposite end of PLAYER RODS. *Note: SOCCER TABLE will be placed on top of assembled BILLIARD TABLE. Follow instructions below to assemble BILLIARD TABLE.*

ASSEMBLY INSTRUCTIONS (CONT.)

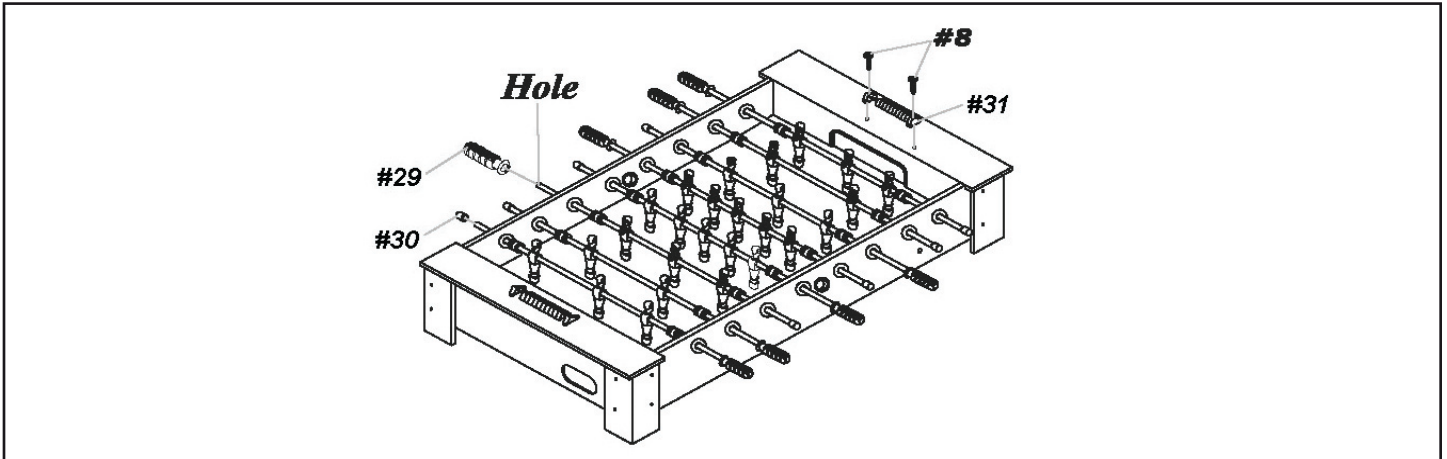

10. To assemble BILLIARD TABLE, attach RIGHT LEGS #23 and LEFT LEGS #24 to the corners of the BILLIARD TABLE BODY #22 as shown below using 1-1/8" BOLT #2 and 5/16" FLAT WASHER #5 or 1-1/2" WING BOLT #3. Note: 1-1/2" WING BOLT #3 is also used to assemble BASKETBALL GAME. See illustration below for WING BOLT PLACEMENT. These are used on opposite end of table from side holes used for attaching SIDE NET in Step 19.

11. Attach one LEG PANEL #25 to each end of the table with 1" BOLT #15 and 1/4" FLAT WASHER #16.

12. Thread one LEG LEVELER #9 onto each LEG. Carefully turn table over.

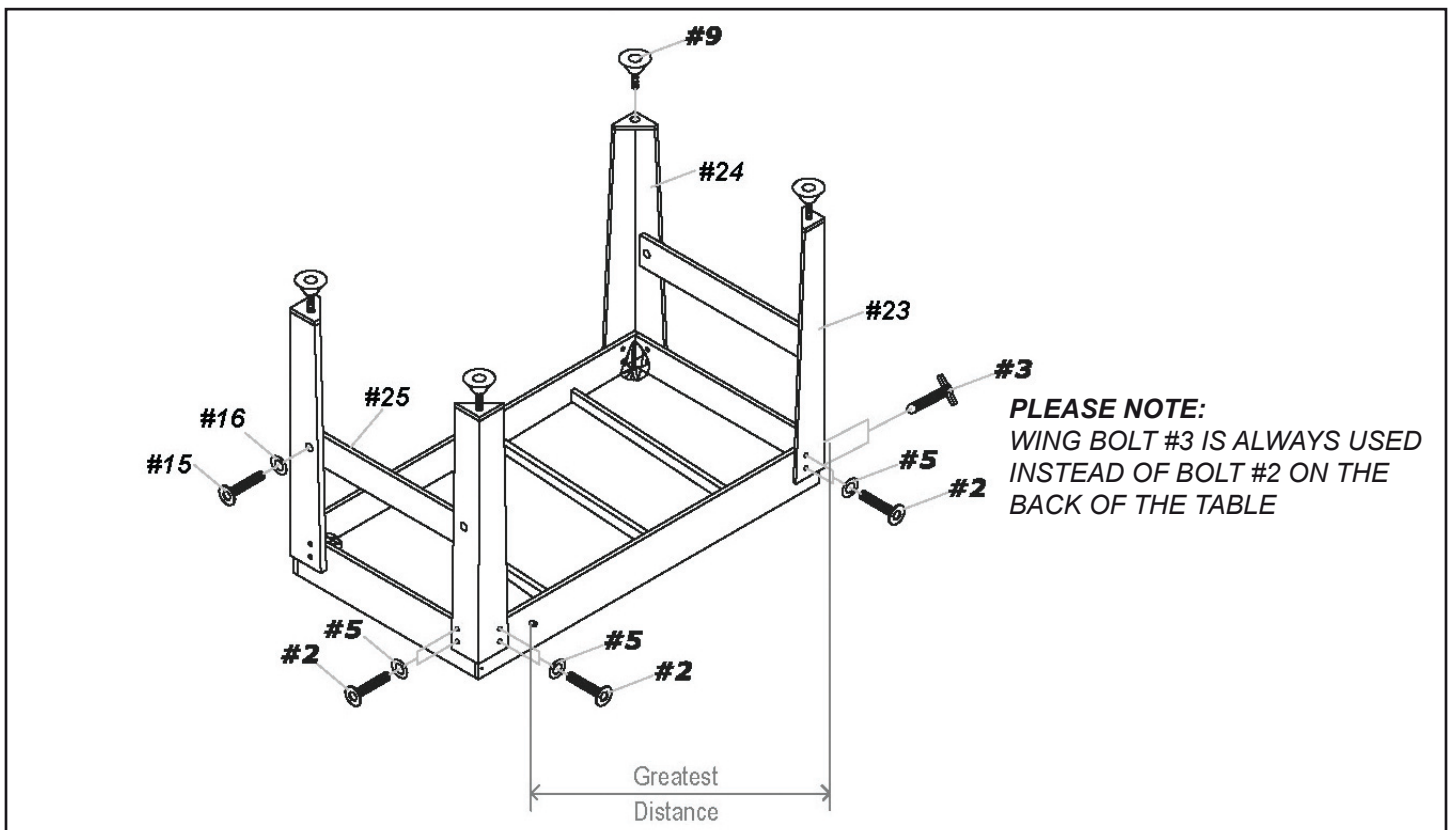

ASSEMBLY INSTRUCTIONS (CONT.)

13. To play HOCKEY, place HOCKEY PLAYFIELD #32B into assembled BILLIARD TABLE. *Note: This is NOT an AIR hockey table. The goals are designed to grab the puck. The puck is not intended to go all the way into the goal.*

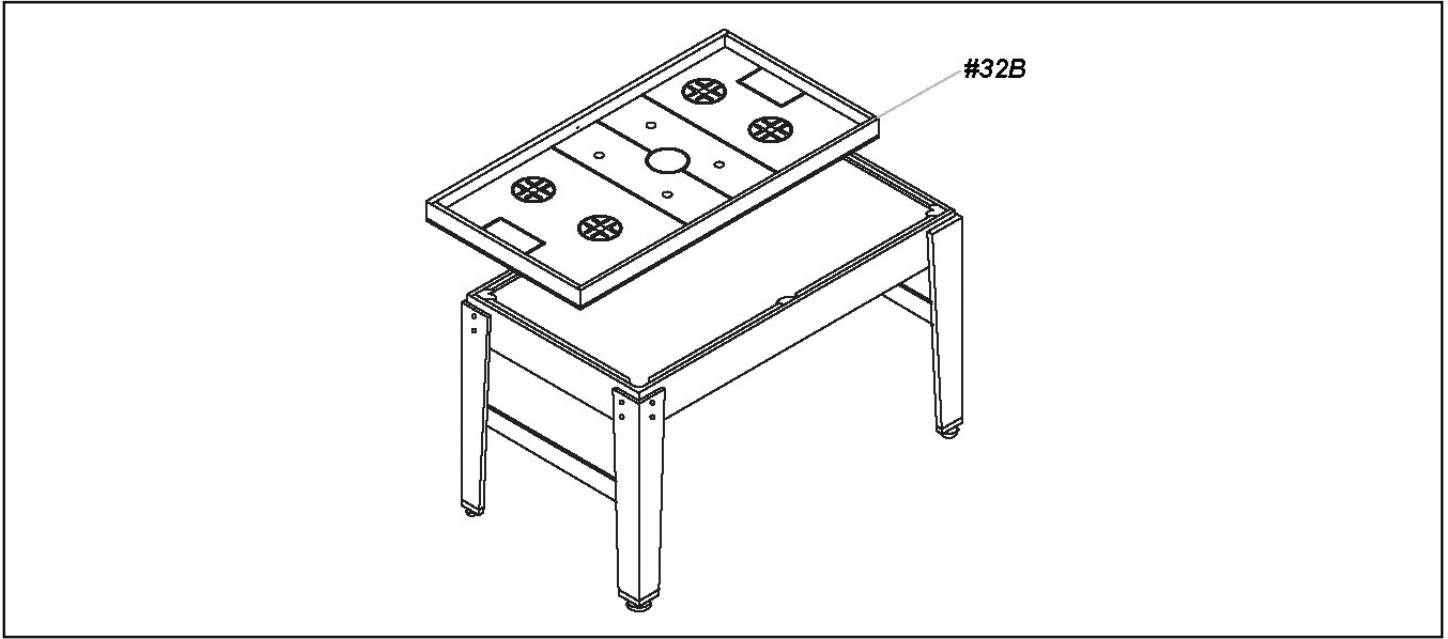

14. To play TABLE TENNIS, flip HOCKEY PLAYFIELD over. Place TABLE TENNIS PLAYFIELD #32A onto assembled BILLIARD TABLE. Insert one TABLE TENNIS NET POST #53 into each side of the TENNIS TABLE PLAYFIELD at the center line. Attach the TABLE TENNIS NET #52 to each POST.

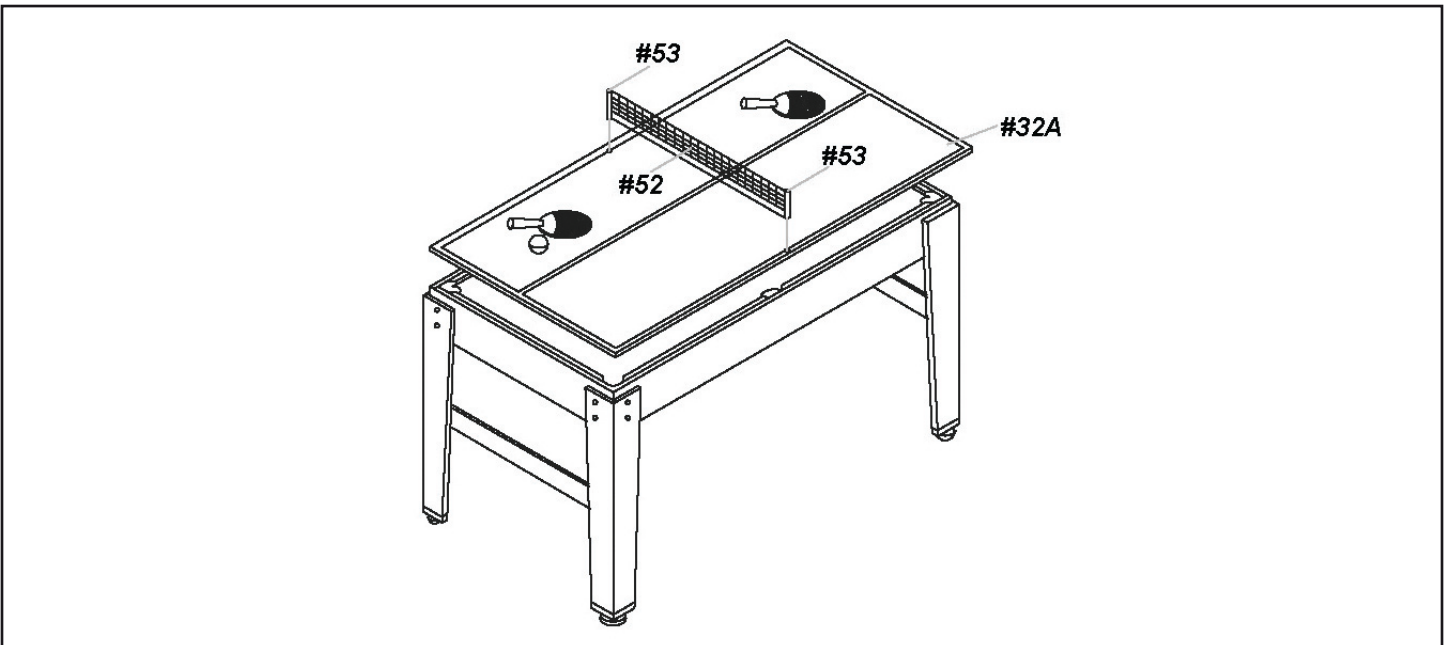

ASSEMBLY INSTRUCTIONS (CONT.)

15. For other GAMES, place GAME BOARD #33 or BASEBALL/FOOTBALL PLAYFIELD #34 into assembled BILLIARD TABLE.

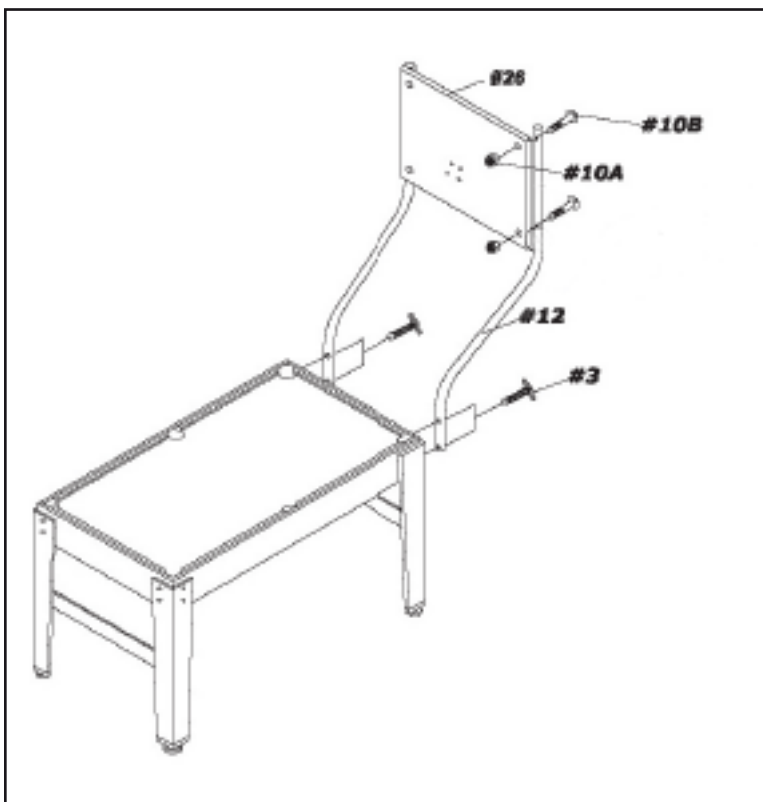
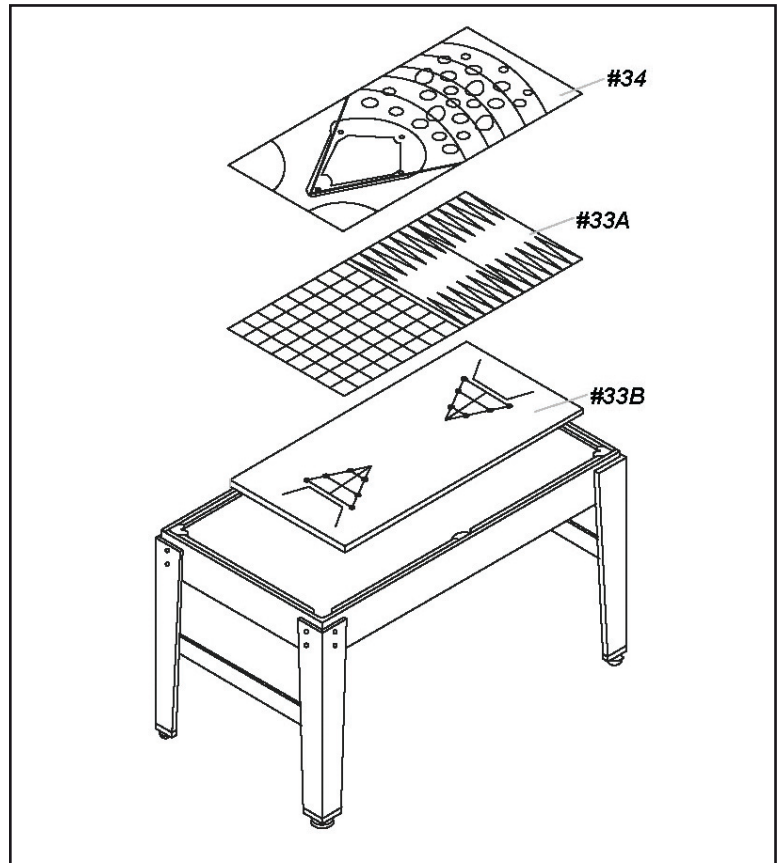

16. To assemble BASKETBALL GAME, attach LOWER BASKETBALL ARM #12 to the back of BILLIARD TABLE with 1-1/2" WING BOLT #3. *Note: 1-1/2" WING BOLT #3 is already part of BILLIARD TABLE assembly.*

17. Attach BASKETBALL BACKBOARD #26 to BASKETBALL ARMS #12 with 5/32" NUT & BOLT #10.

ASSEMBLY INSTRUCTIONS (CONT.)

18. Attach BASKETBALL RIM #27 to BASKETBALL BACKBOARD with 5/8" SCREW #7.

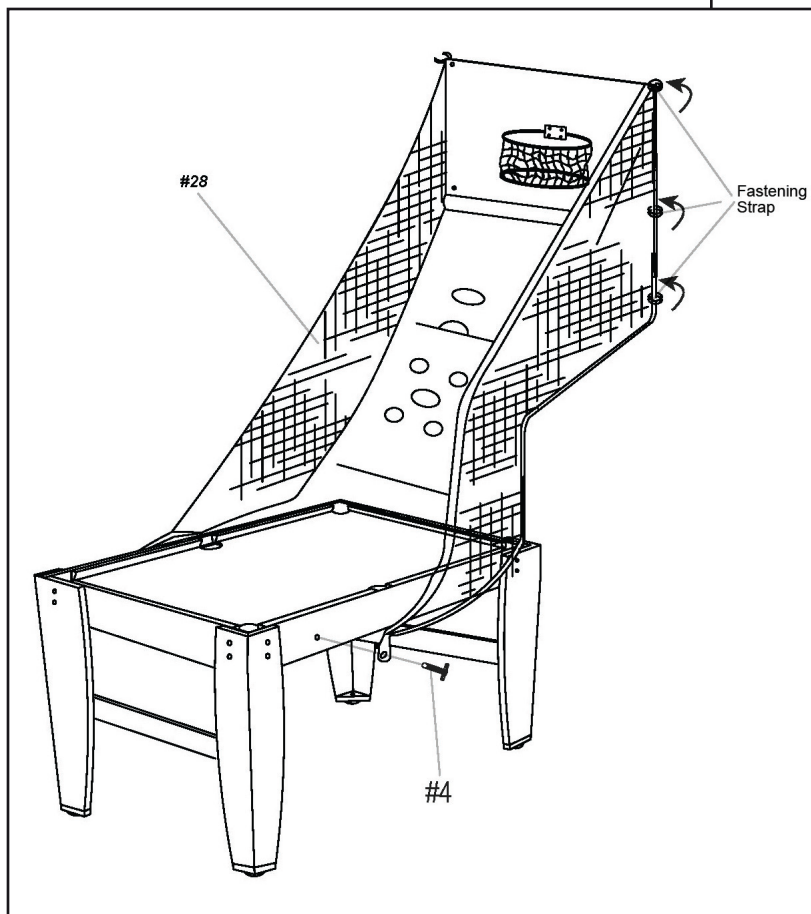
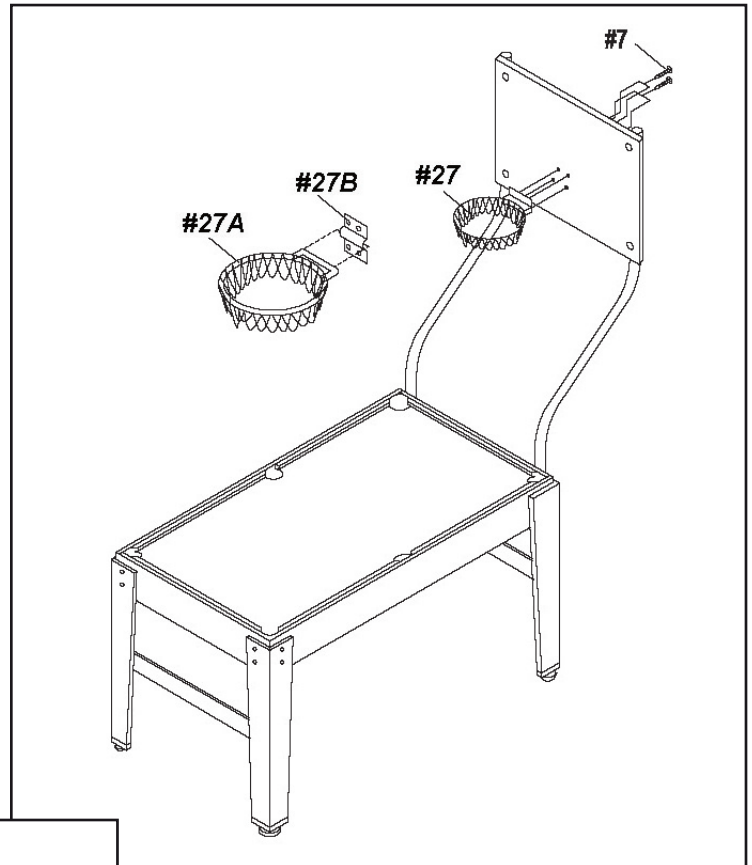

19. Attach BASKETBALL SIDE NET #28 by securing to BASKETBALL ARMS as shown with fastening strap. Attach BASKETBALL SIDE NET #28 to BILLIARD TABLE BODY as shown with 3/4" WING BOLT #4.
Note: Loosening BASKETBALL BACKBOARD bolts slightly may help when fastening upper straps of BASKETBALL SIDE NET.

CONGRATULATIONS!

You have now assembled your Game Table.
Please note the Care and Use instructions below to ensure years of trouble free use of your game table.

CARE AND USE

1. This product is intended for **INDOOR** use only.
2. Do **NOT** sit, climb or lean on the table.
3. Do **NOT** drag the table when moving it as this will damage the legs.

GAME LIST

The Inferno 20-in-1 Multi-Game includes the following games:

- | | |
|-----------------|----------------------|
| 1 Soccer | 11 Backgammon |
| 2 Pool | 12 Bowling |
| 3 Glide Hockey | 13 Finger Football |
| 4 Table Tennis | 14 Baseball |
| 5 Basketball | 15 Tic-Tac-Toe |
| 6 Chess | 16 Dice |
| 7 Checkers | 17 Cards |
| 8 Ring Toss | 18 Mini Stick Hockey |
| 9 Horseshoes | 19 Bean Bag Toss |
| 10 Shuffleboard | 20 Football Toss |

Please refer to the Assembly Instructions and the Game Play Instructions to set up and play the games.

GAME PLAY INSTRUCTIONS

Ring Toss

Accessories Needed for Play:

1. Rings #74
2. Ring Toss Post #75 (*NOTE: the post does not stick well to the Ping Pong or Shuffleboard tables. Use the hockey table, football field or another smooth hard surface for best results).*)

How to Play:

The objective is to score the most points by tossing the rings around the post. Before play, designate a number of points needed to win. Each player must stand back and toss his/her rings towards the post. The first player to reach the score designated at the beginning of the game wins!

Horseshoes

Accessories Needed for Play:

1. Horseshoes #73
2. Ring Toss Post #75

How to Play:

The objective is to score the most points by tossing the horseshoes around the post. Before play, designate a number of points needed to win. Each player must stand back and toss his/her horseshoes towards the post. The first player to reach the score designated at the beginning of the game wins!

Shuffleboard

Accessories Needed for Play:

1. Shuffleboard Pucks #72
2. Game Board (Shuffleboard Side Up) #33B

How to Play:

Players face the pointed end of the shuffleboard triangle. The objective is to push your pucks into any of the designated scoring areas inside of the triangle. Players take turns pushing their pucks. Once all of the pucks have been sent down the board, the player with the highest score wins that round. Play continues in the opposite direction. The first person to reach 15 or 21 wins!

Bowling

Accessories Needed for Play:

1. Bowling Pins #70
2. Bowling Ball #71
3. Game Board (Shuffleboard Side Up) #33B

How to Play:

The objective is to knock down the highest number of pins in each round or "frame." Set up the 10 pins in the triangle pattern printed on the shuffleboard surface. Roll the ball towards the pins and keep track of how many pins have been knocked down per frame. Each player gets to roll the ball twice per round. The player with the highest score at the end of 10 rounds wins!

GAME PLAY INSTRUCTIONS (CONT.)

Finger Football

Accessories Needed for Play:

1. Finger Football Triangles #55
2. Football Goal Post #54
3. Baseball/Football Playfield (Football Side Up) #34

How to Play:

The objective is to flick your finger football into the scoring zone on the opposite side of the board. Begin by designating a number of points, or a time limit to play to. Players can score by flicking the football into the opposing end zone, or by flicking it through the goal posts. Players can use traditional football scoring, or they can set up their own rules. The player with the highest score at the end of the game wins.

Baseball

Accessories Needed for Play:

1. Baseball #62
2. Baseball Bat #63
3. Baseball Markers #64
4. Baseball/Football Playfield (Baseball Side Up) #34

How to Play:

The main objective is to score the most points by flicking the baseball with the bat into the different scoring areas on the opposite end of the playfield. Use the baseball markers to move your team around the diamond based on where the ball lands. For example, if the baseball lands in the bubble marked "double," move the baseball marker to second base. Like regular baseball, each player gets 3 strikes and 3 outs. The player with the highest score at the end of the game wins!

Tic-Tac-Toe

Accessories Needed for Play:

1. Tic-Tac-Toe Grid #41
2. Tic-Tac-Toe Pieces #41

How to Play:

Each player is represented by either the X or the O. Both players take turns placing 1 piece on the board at a time. The object is to be the first to get 3 of their pieces in a row vertically, horizontally, or diagonally.

Playing Cards

Accessories Needed for Play:

1. Playing Cards #48

Overview:

There are hundreds of popular card games for kids and adults alike. Variations include:

- Go Fish
- Solitaire
- Crazy Eights
- Spoons
- Memory

GAME PLAY INSTRUCTIONS (CONT.)

Mini Stick Hockey

Accessories Needed for Play:

1. Hockey Pucks #45
2. Hockey Sticks #45
3. Hockey Goal #44
4. Table Tennis/Hockey Playfield (Hockey Side Up) #32B

How to Play:

Before beginning game play, designate a number of points or time limit to play to. Use the mini hockey sticks to push the pucks into your opponent's goal while protecting your own! The player who scores the most goals wins!

Bean Bag Toss

Accessories Needed for Play:

1. Bean Bags #46
2. Basketball Side Net #28
3. Basketball Backboard #26
4. Lower Basketball Arms #12
5. Upper Basketball Arms #13

How to Play:

Each hole in the bean bag toss target is numbered with a point value. Players stand back and toss their bean bags into the intended target. The player with the most points at the end of the game wins!

Football Toss

Accessories Needed for Play:

1. Football #47
2. Basketball Side Net #28
3. Basketball Backboard #26
4. Lower Basketball Arms #12
5. Upper Basketball Arms #13

How to Play:

Each hole in the football toss target is numbered with a point value. Players stand back and throw the football into the intended target. The player with the most points at the end of the game wins!

180-DAY LIMITED WARRANTY

This product is warranted to the original purchaser to be free from defects in material or workmanship for a period of 180 days from the date of the original retail purchase.

This warranty does not cover defects or damage due to improper installation, alteration, accident or any other event beyond the control of the manufacturer. Defects or damage resulting from misuse, abuse or negligence will void this warranty. This warranty does not cover scratching or damage that may result from normal usage.

This product is not intended for institutional or commercial use; the manufacturer does not assume any liability for such use. Institutional or commercial use will void this warranty.

This warranty is nontransferable and is expressly limited to the repair or replacement of the defective product. During the warranty period, the manufacturer shall repair or replace defective parts at no cost to the purchaser. Shipping charges and insurance are not covered and are the responsibility of the purchaser. Labor charges and related expenses for removal, installation or replacement of the product or components are not covered under this warranty.

The manufacturer reserves the right to make substitutions to warranty claims if parts are unavailable or obsolete.

The manufacturer shall not be liable for loss of use of the product or other consequential or incidental costs, expenses or damages incurred by the consumer of any other use. The user assumes all risk of injury resulting from the use of this product.

This warranty is expressly in lieu of all other warranties, expressed or implied, including warranties of merchantability or fitness for use to the extent permitted by Federal or state law. Neither the manufacturer nor any of its representatives assumes any other liability in connection with this product.

All warranty claims must be made through the retailer where the product was originally purchased. A purchase receipt or other proof of date of purchase will be required to process all warranty claims. The model number and part numbers found within the assembly instructions will be required when submitting any parts requests or warranty claims.







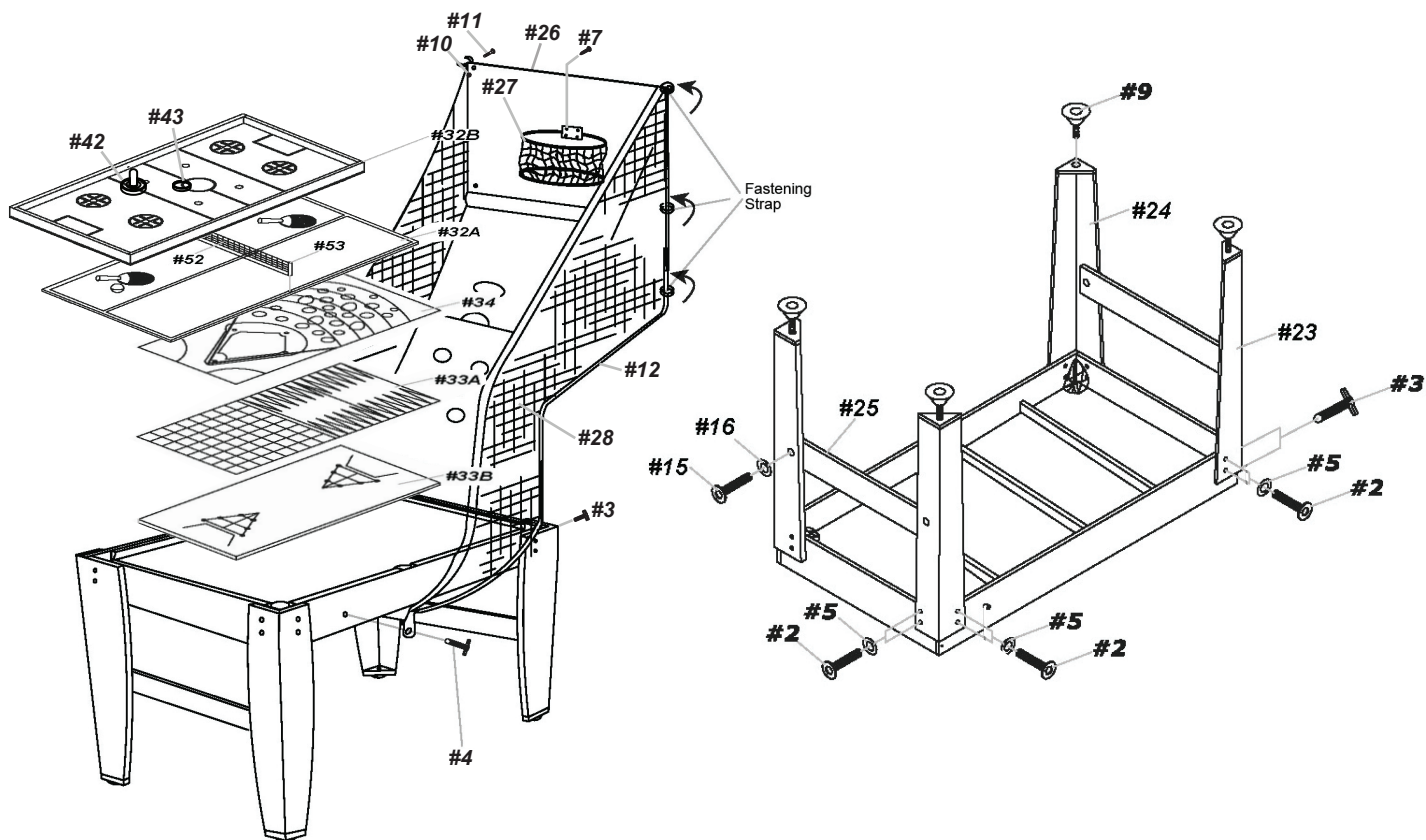
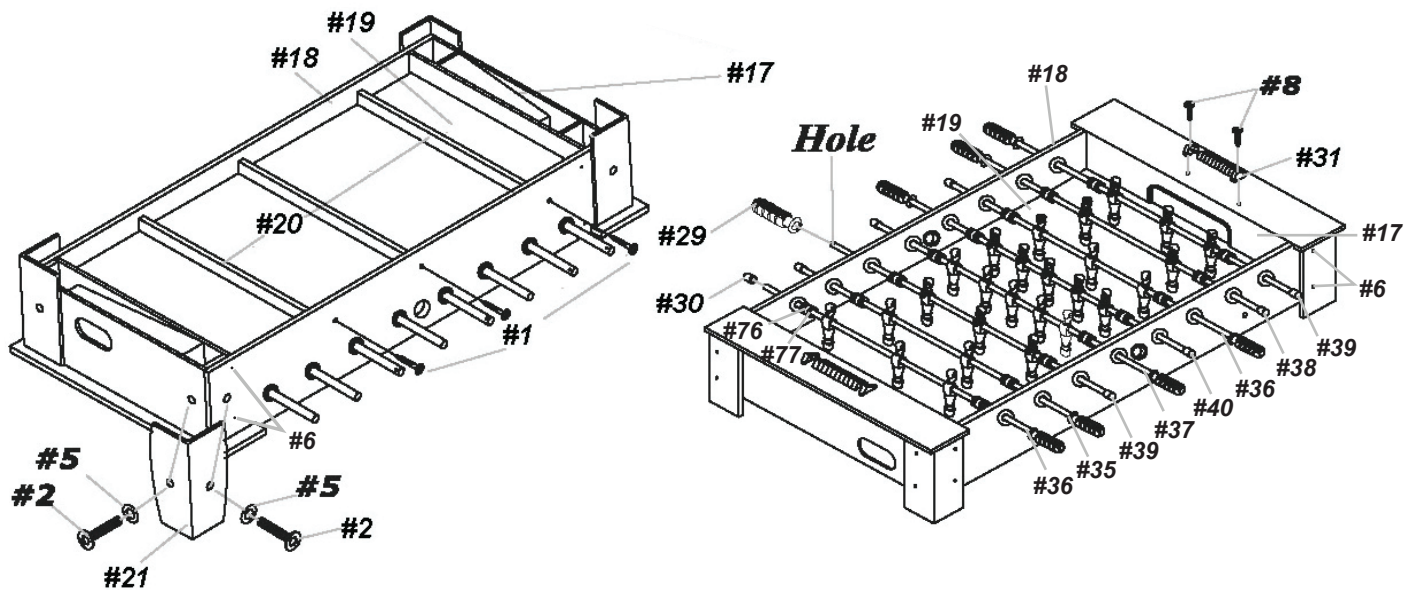





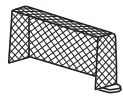

For further warranty information or inquiries, please call 800-759-0977

INFERNO 20-IN-1 MULTI-GAME - NG1017M3















Parts List



PARTS

#12 NGP50573  BASKETBALL ARM 2 pcs	#17 NGP50023  END PANEL 2 pcs	#18 NGP50033  SIDE PANEL 2 pcs	#19 NGP50043  SOCCER PLAYFIELD 1 pc	#20 NGP50053  SUPPORT BRACE 3 pcs	#21 NGP50063  CORNER 4 pcs	#22 NGP50453  BILLIARD TABLE BODY 1 pc
#23 NGP50073  RIGHT LEG 2 pcs	#24 NGP50083  LEFT LEG 2 pcs	#25 NGP50093  LEG PANEL 2 pcs	#26 NGP50103  BASKETBALL BACKBOARD 1 pc	#27 NGP50113  BASKETBALL RIM 1 pc	#28 NGP50123  BASKETBALL SIDENET 1 pc	#29 NGP50133  HAND GRID 8 pcs
#30 NGP50143  ROD END CAP 8 pcs	#31 NGP50153  MANUAL SCORER 2 pcs	#32 NGP50163  TABLE TENNIS/ HOCKEY PLAYFIELD 1 pc	#33 NGP50173  GAME BOARD 1 pc	#34 NGP50183  BASEBALL/ FOOTBALL PLAYFIELD 1 pc	#35 NGP50593  Player: NGP50633 2 AWAY PLAYER ROD 1 pc	#36 NGP50603  Player: NGP50633 3 AWAY PLAYER ROD 2 pcs
#37 NGP50613  Player: NGP50633 5 AWAY PLAYER ROD 1 pc	#38 NGP50593  Player: NGP50623 2 HOME PLAYER ROD 1 pc	#39 NGP50603  Player: NGP50623 3 HOME PLAYER ROD 2 pcs	#40 NGP50613  Player: NGP50623 5 HOME PLAYER ROD 1 pc	#41 NGP50193  TIC TAC TOE 1 SET	#42 NGP5020  STRIKER 2 pcs	#43 NGP5021  PUCK 2 pcs
#44 NGP50223  HOCKEY GOAL 1 SET	#45 NGP50233  HOCKEY STICK 2 pcs	#46 NGP50243  BEAN BAGS 1 SET	#47 NGP50253  FOOTBALL 1 pc	#48 NGP50263  PLAYING CARDS 1 SET	#49 NGP5027  SOCCER BALL 2 pcs	#50 NGP5028  TABLE TENNIS PADDLE 2 pcs
#51 NGP5029  TABLE TENNIS BALL 2 pcs	#52 NGP50303  TABLE TENNIS NET 1 pc	#53 NGP50303  TABLE TENNIS NET POST 2 pcs	#54 NGP50323  FOOTBALL GOAL POST 1 pc	#55 NGP50333  FINGER FOOTBALL 4 pcs	#56 NGP50343  BASKETBALL 1 pc	#57 NGP5035  AIR PUMP 1 pc
#58 NGP5036  DICE 1 SET	#59 NGP50373  DICE CUP 1 pc	#60 NGP50383 NGP50393  CHESS 1 SET	#61 NGP50403 NGP50413  CHECKERS 1 SET	#62 NGP50423  BASEBALL 1 SET	#63 NGP50433  BASEBALL BAT 2 pcs	#64 NGP50443  BASEBALL MAKER 1 SET
#65 NGP5077  CHALK 2 pcs	#66 NGP5074  BILLIARD BALLS 1 SET	#67 NGP5073  BRUSH 1 pc	#68 NGP5048  CUE STICK 2 PCS	#69 NGP5049  TRIANGLE 1 pc	#70 NGP50503  BOWLING PINS 1 SET	#71 NGP50513  BOWLING BALL 1 pc
#72 NGP50523 NGP50533  SHUFFLEBOARD PUCKS 1 SET	#73 NGP50543  HORSESHOES 1 SET	#74 NGP50553  RING TOSS 1 SET	#75 NGP50563  RING TOSS POST 1 pc	#76 NGP50643  FOAM BUMPER 16 pcs	#77 NGP50653  PLASTIC ROD WASHER 16 pcs	

HARDWARE PACK - NGP50013

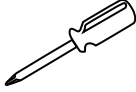
<p>#1</p>  <p>1-3/4" ROUND SCREW 6 pcs</p>	<p>#2</p>  <p>1-1/8" BOLT 20 pcs</p>	<p>#3</p>  <p>1-1/2" WING BOLT 4 pcs</p>	<p>#4</p>  <p>3/4" BOLT 2 pcs</p>	<p>#5</p>  <p>5/16" FLAT WASHER 20 pcs</p>	<p>#6</p>  <p>1-3/4" FLAT SCREW 8 pcs</p>	<p>#7</p>  <p>5/8" SCREW 4 pcs</p>
<p>#8</p>  <p>1" FLAT SCREW 4 pcs</p>	<p>#9</p>  <p>LEG LEVELER 4 pcs</p>	<p>#10</p> <p>A</p>  <p>5/32" NUT 4 pcs</p>	<p>#10</p> <p>B</p>  <p>5/32" BOLT 4 pcs</p>	<p>#12</p>  <p>HEX WRENCH 1 pc</p>	<p>#15</p>  <p>1" BOLT 4 pcs</p>	<p>#16</p>  <p>1/4" FLAT WASHER 4 pcs</p>
<p>ADDITIONAL EQUIPMENT REQUIRED:</p>  <p>PHILLIPS HEAD SCREWDRIVER</p>						