

# BOUNCEBACK 9' TABLE TENNIS ASSEMBLY INSTRUCTIONS



NG2325B











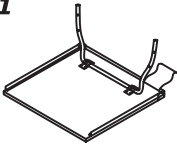
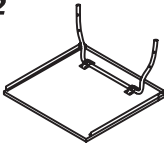







**THANK YOU!**

Thank you for purchasing this product.

We work around the clock and around the globe to ensure that our products maintain the highest possible quality. However, in the rare instance that your product is defective or missing parts, contact your retailer, or call 800-759-0977, to submit parts requests or warranty claims. Please read the warranty information at the back of these assembly instructions for further details.

**IMPORTANT! PLEASE READ THESE ASSEMBLY INSTRUCTIONS  
IN ENTIRETY BEFORE ASSEMBLING YOUR PRODUCT.**

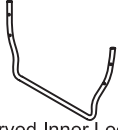
# PARTS IDENTIFIER (NOT TO SCALE)

<p><b>#1</b></p>  <p>Table Surface with Bag 1 set</p>	<p><b>#2</b></p>  <p>Table Surface with Strap 1 set</p>	<p><b>#3</b></p>  <p>Plastic Plate with Steel Frame 2 pieces</p>	<p><b>#4</b></p>  <p>Safety Lock 2 pieces</p>	<p><b>#5</b></p>  <p>4X12MM Screw 24 pieces</p>
<p><b>#6</b></p>  <p>Linkage Tube 2 pieces</p>	<p><b>#7</b></p>  <p>6MM Washer 28 pieces</p>	<p><b>#8</b></p>  <p>Metal Bracket 4 pieces</p>	<p><b>#9</b></p>  <p>8MM Bushing 10 pieces</p>	<p><b>#10</b></p>  <p>6X70MM Bolt 10 pieces</p>
<p><b>#11</b></p>  <p>Caster with Lock 4 pieces</p>	<p><b>#12</b></p>  <p>6MM Locking Nut 10 pieces</p>	<p><b>#13</b></p>  <p>6X57MM Bolt 8 pieces</p>	<p><b>#14</b></p>  <p>Tube with Stop Bracket 2 pieces</p>	<p><b>#15</b></p>  <p>Allen Tool 1 piece</p>
<p><b>#16</b></p>  <p>6MM Wrench 1 piece</p>	<p><b>#17</b></p>  <p>Net Post 2 pieces</p>	<p><b>#18</b></p>  <p>Net 1 piece</p>	<p><b>#19</b></p>  <p>Curved Inner Leg with Caster Insert and Pin 2 pieces</p>	<p><b>#20</b></p>  <p>Paddle 2 pieces</p>
<p><b>#21</b></p>  <p>Table Tennis Ball 3 pieces</p>				

**ADDITIONAL EQUIPMENT REQUIRED:**



Please see Parts List at end of manual for part number when ordering parts. For replacement parts please call 800-759-0977.

## ASSEMBLY TIPS

1. Find a clean, level surface to begin the assembly of your game table. The table will be partially assembled upside down and then turned over onto its legs. This is a heavy game and turning it over will require at least two strong adults.
2. Remove all of the contents from box and verify that you have all of the parts shown on the Parts Identifier before you begin assembly. **Note: Some parts may be pre-installed or pre-assembled.**
3. Some figures or drawings may not look exactly like your product. Please read and understand the text before beginning each assembly step.
4. **When installing parts that have more than one screw or bolt, hand tighten all screws or bolts in place before finishing tightening with screwdriver or hex wrench.**
5. Electric screwdrivers may be helpful during assembly; however, please set a low torque and use extreme caution because screws may be stripped or overtightened if the electric screwdriver's torque is set too high.

### **WARNINGS!**

READ AND FOLLOW ALL ASSEMBLY, OPERATION AND SAFETY INSTRUCTIONS CAREFULLY.

CHOKER HAZARD - THIS TABLE CONTAINS SMALL BALLS AND PARTS - NOT SUITABLE FOR CHILDREN UNDER 3 YEARS OF AGE.

# ASSEMBLY INSTRUCTIONS

1. Unfold the outer pre-assembled leg on backside of surface to straight position.
2. Assemble the inner leg #19 to the backside of the surface #1 and #2 with metal bracket #8 with screw #5.

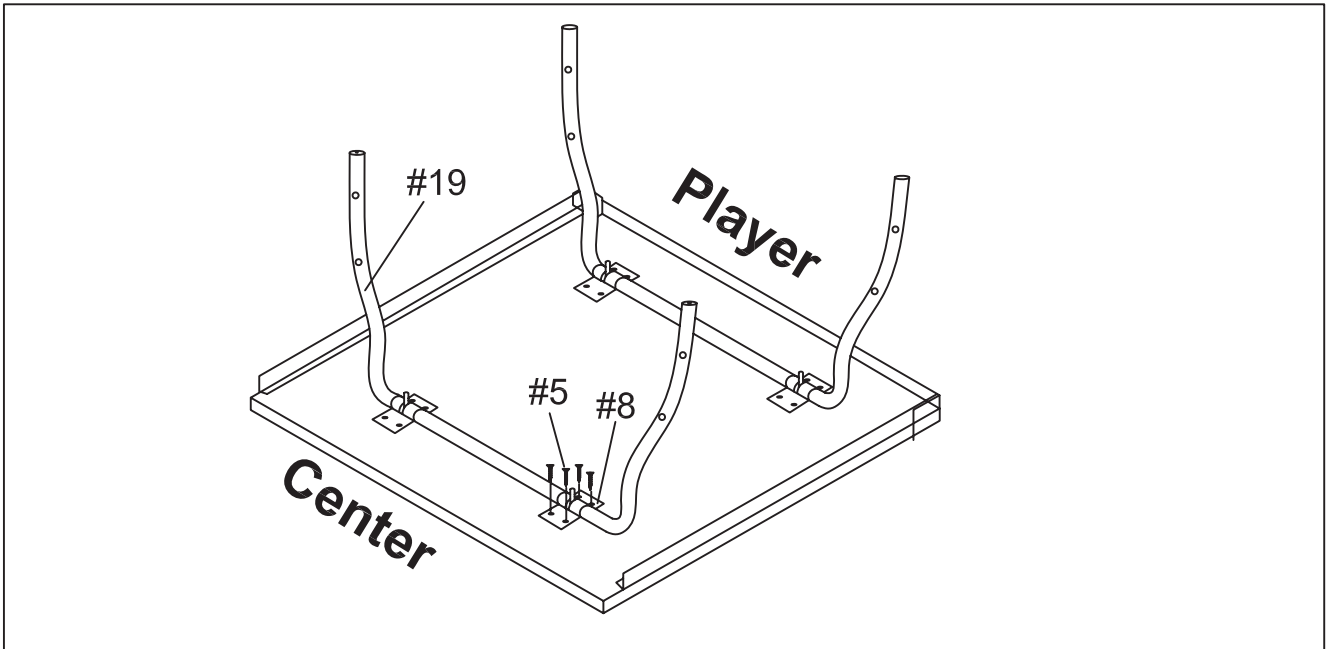

**NOTE: One end of linkage tube is assembled inside the leg and the other end is outside the leg as shown below.**

3. Attach the linkage tube #6 and tube with stop bracket #14 to the legs with bolt #10, washer #7, bushing #9 and nut #12.

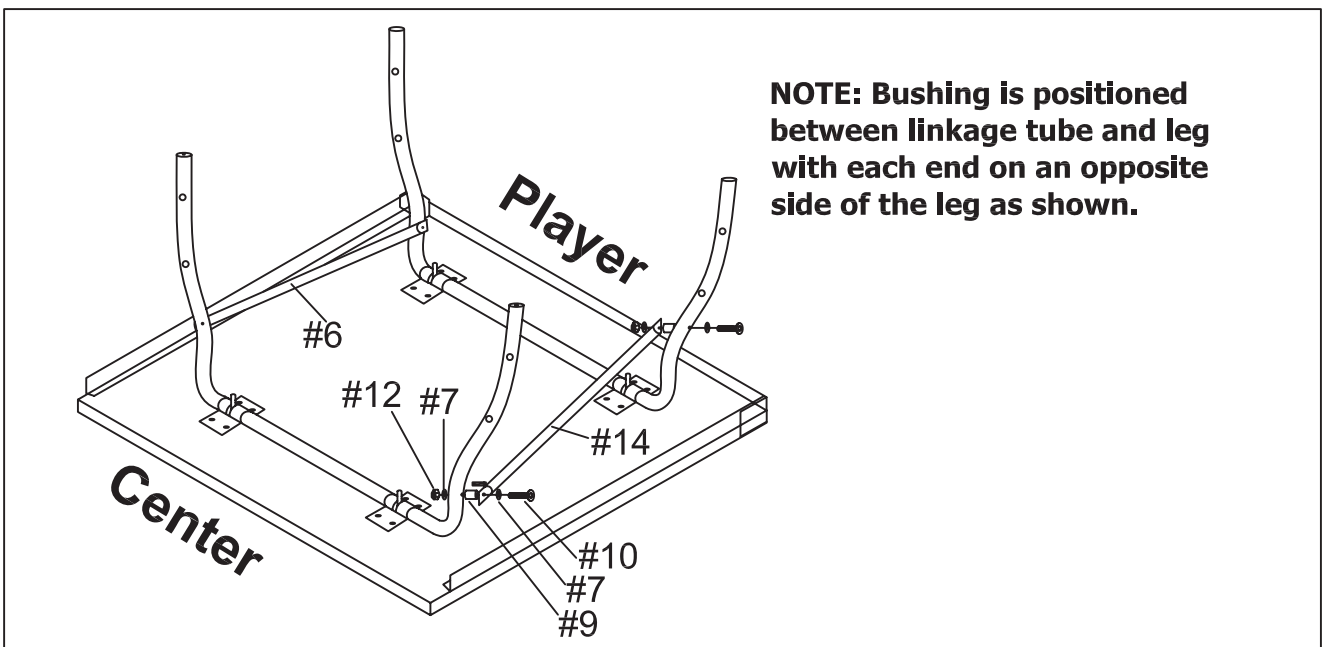

# ASSEMBLY INSTRUCTIONS

4. Thread the locking caster #11 to the inner center leg bottom. Attach the plastic plate with steel frame #3 to the inner leg with bolt #13.

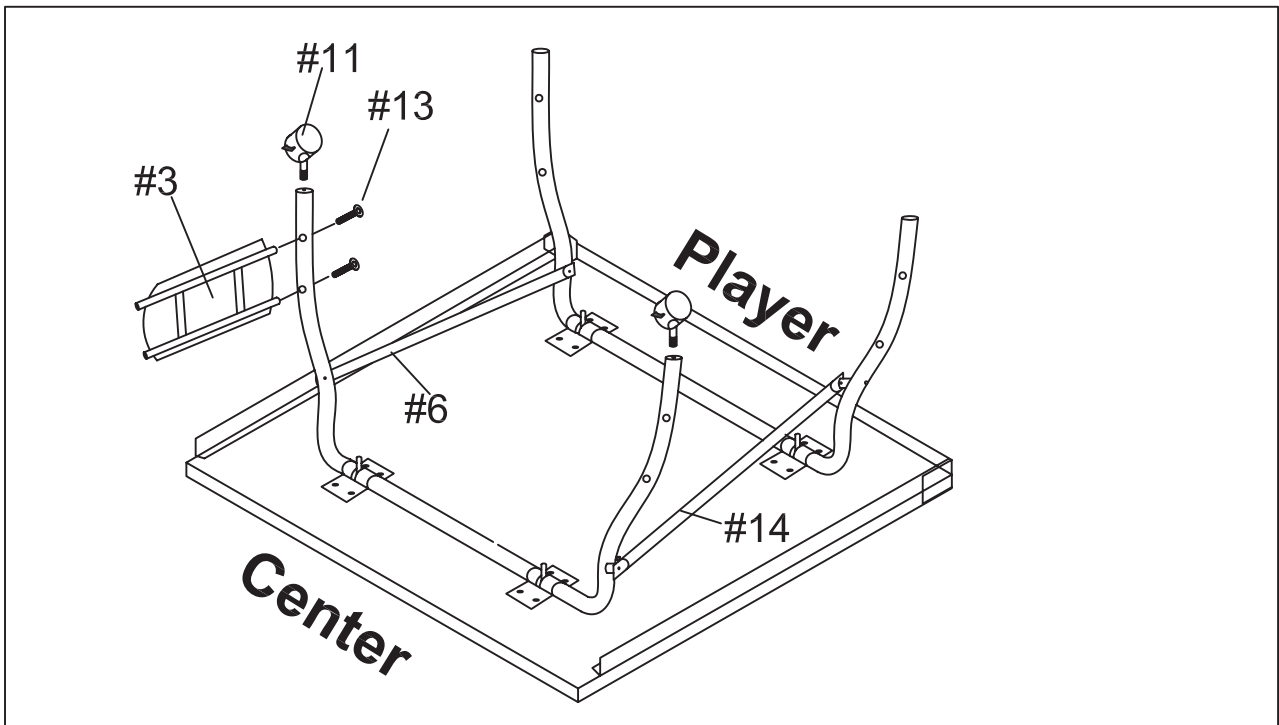

5. Turn the two table surfaces over carefully, attach the plastic plate with steel frame #3 with bolt #13 to opposite table leg as shown.

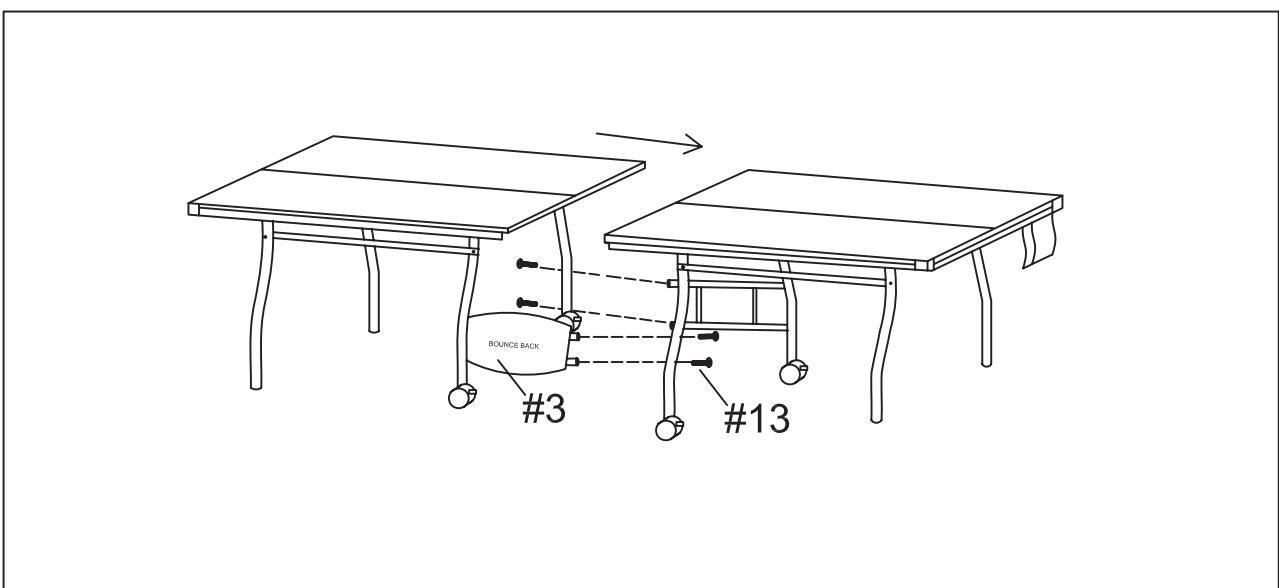

# ASSEMBLY INSTRUCTIONS

6. Attach the safety lock #4 to the inner leg with Bolt #10, washer #7, bushing #9 and nut #12 as below.

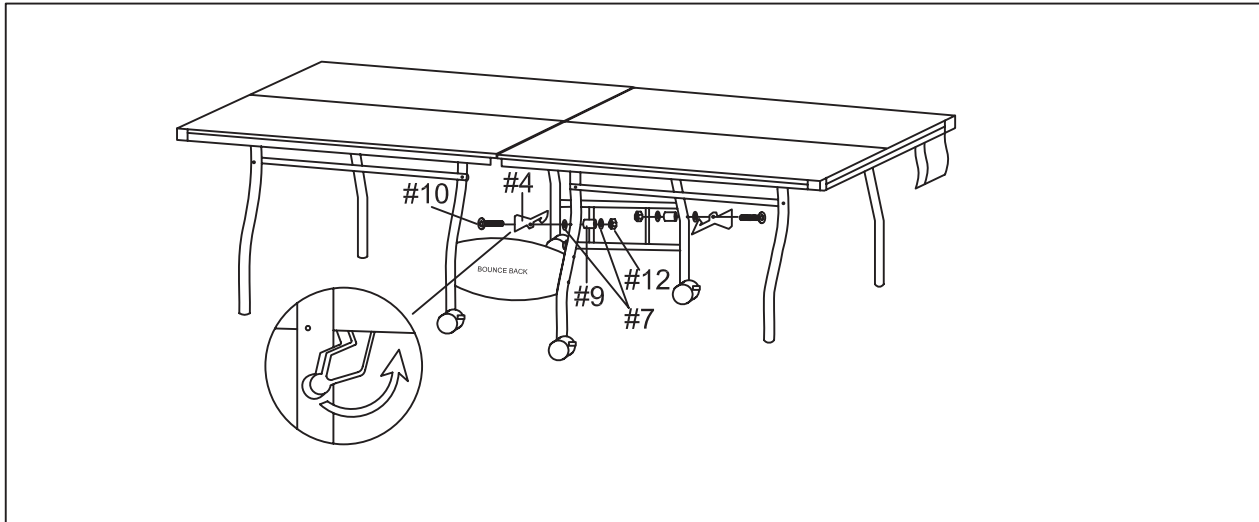

7. Attach the net post #17 to the center of the table, insert the net #18 onto the post.

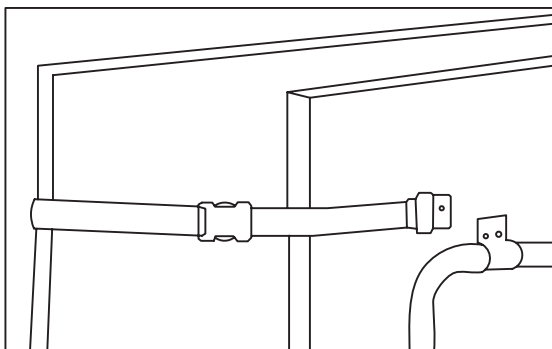
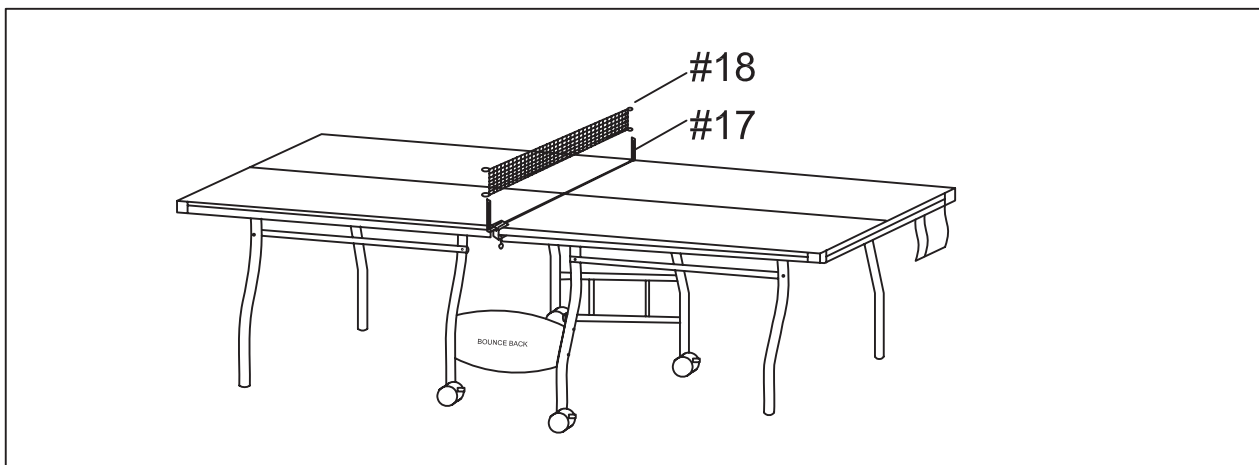

Clip the strap buckles together when folding the two surfaces for storage.

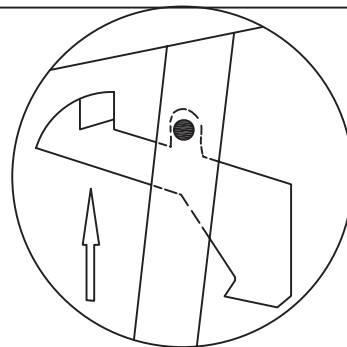

Push up the safety lock when folding up for storage.  
Push down to open the folded surface for play.

**CONGRATULATIONS!**

You have now assembled your Game Table. Please note the Care and Use instructions below to ensure years of trouble free use of your game table.

### **CARE AND USE**

1. This product is intended for INDOOR use only.
2. Do NOT sit, climb or lean on the table.
3. Do NOT drag the table when moving it as this will damage the legs.



# 180-DAY LIMITED WARRANTY

This product is warranted to the original purchaser to be free from defects in material or workmanship for a period of 180 days from the date of the original retail purchase.

This warranty does not cover defects or damage due to improper installation, alteration, accident or any other event beyond the control of the manufacturer. Defects or damage resulting from misuse, abuse or negligence will void this warranty. This warranty does not cover scratching or damage that may result from normal usage.

This product is not intended for institutional or commercial use; the manufacturer does not assume any liability for such use. Institutional or commercial use will void this warranty.

This warranty is nontransferable and is expressly limited to the repair or replacement of the defective product. During the warranty period, the manufacturer shall repair or replace defective parts at no cost to the purchaser. Shipping charges and insurance are not covered and are the responsibility of the purchaser. Labor charges and related expenses for removal, installation or replacement of the product or components are not covered under this warranty.

The manufacturer reserves the right to make substitutions to warranty claims if parts are unavailable or obsolete.

The manufacturer shall not be liable for loss of use of the product or other consequential or incidental costs, expenses or damages incurred by the consumer of any other use. The user assumes all risk of injury resulting from the use of this product.

This warranty is expressly in lieu of all other warranties, expressed or implied, including warranties of merchantability or fitness for use to the extent permitted by Federal or state law. Neither the manufacturer nor any of its representatives assumes any other liability in connection with this product.

**All warranty claims must be made through the retailer where the product was originally purchased. A purchase receipt or other proof of date of purchase will be required to process all warranty claims. The model number and part numbers found within the assembly instructions will be required when submitting any parts requests or warranty claims.**







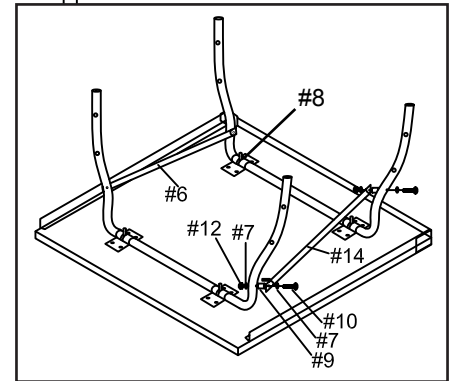
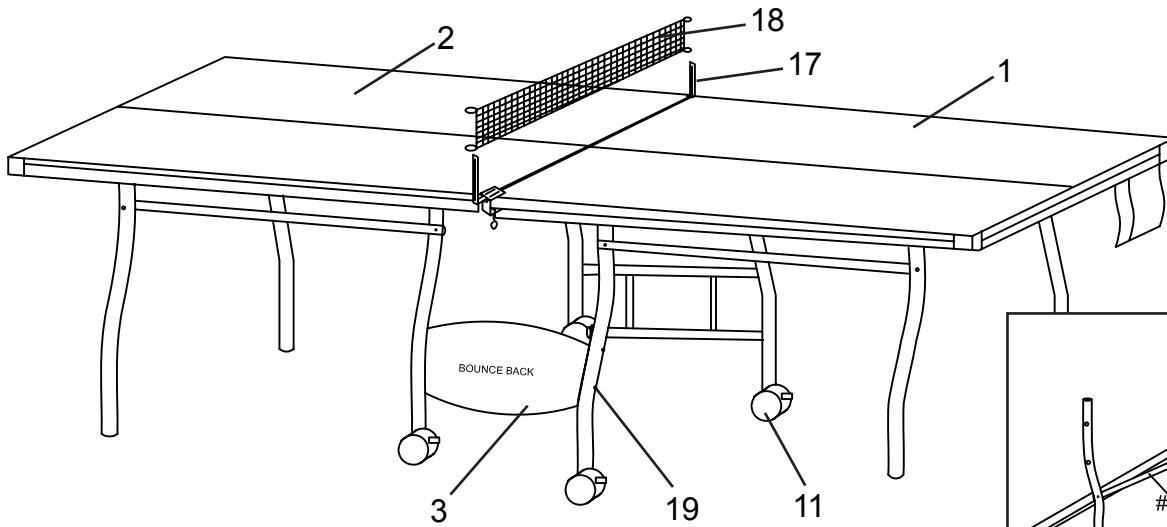

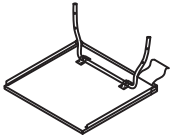
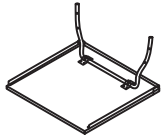

**For further warranty information or inquiries, please call 800-759-0977**

# 9' BOUNCEBACK TABLE TENNIS - NG2325B





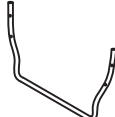



## Parts List



### PARTS

#1 NGP5931  TABLE SURFACE	#2 NGP5932  TABLE SURFACE	#3 NGP5933  LEG PANEL	#4 NGP5934  SAFETY LOCK	#6 NGP5935  LINKAGE TUBE	#8 NGP5936  METAL BRACKET	#11 NGP5937  LOCKING CASTER
#14 NGP5938  LINKAGE TUBE W/ STOP BRCKT.	#17 NGP5939  NET POST	#18 NGP5940  NET	#19 NGP5941  CRVD. INNER LEG	#20 NGP2515  TABLE TENNIS PADDLE	#21 NGP5029  TABLE TENNIS BALL	

### HARDWARE PACK - NGP5942

#5  4X12 MM SCREW	#7  6 MM WASHER	#9  8 MM BUSHING	#10  6X70 MM BOLT	#12  6 MM LOCKING NUT	#13  6X57 MM BOLT	#15  ALLEN WRENCH
#16  HEX WRENCH						