

1. INSTALLING YOUR ABOVEGROUND POOL

The pool must be installed only on level, firm (undug, non-filled) earth. We do not recommend backfilling or grading earth up against the pool wall or frame covering any part of them.

- Check local building codes for setback from house and property lines.
- Check regulations concerning fence height and position.
- Check above and below ground for existing gas, electric, telephone and water lines and any surrounding trees or bushes that might interfere with your pool location...

- 2. STEPS TO INSTALL YOUR OVAL POOL (following numbers on installation sheet)
6 Tools required.
7-18 Layout, ground preparation and ground leveling (in areas prone to nutgrass (Southern U.S.) sterilize soil with approved chemical).
19 Check and layout parts.
20 Preassemble angle and bottom brace on all buttress posts.

* THIS INSTALLATION IS FOR AN OVERLAP LINER. FOR OTHER LINER TYPES, CHECK LINER BOX FOR INSTRUCTIONS.

3. ABOVEGROUND POOL PARTS LIST

Table with columns for size, quantity, and part name. Includes items like Margelle, Poteau Vertical, and various connectors and tracks.

4. ACTUAL SIZE

Table showing actual dimensions for different pool sizes: 12' x 18', 12' x 24', 16' x 26', and 16' x 32'.

5. SAFETY CONSIDERATIONS

NO DIVING, NO JUMPING, SHALLOW WATER. DIVING MAY CAUSE DEATH, PARALYSIS OR PERMANENT INJURY. Jumping or diving into a pool or any aboveground pool is strictly forbidden.

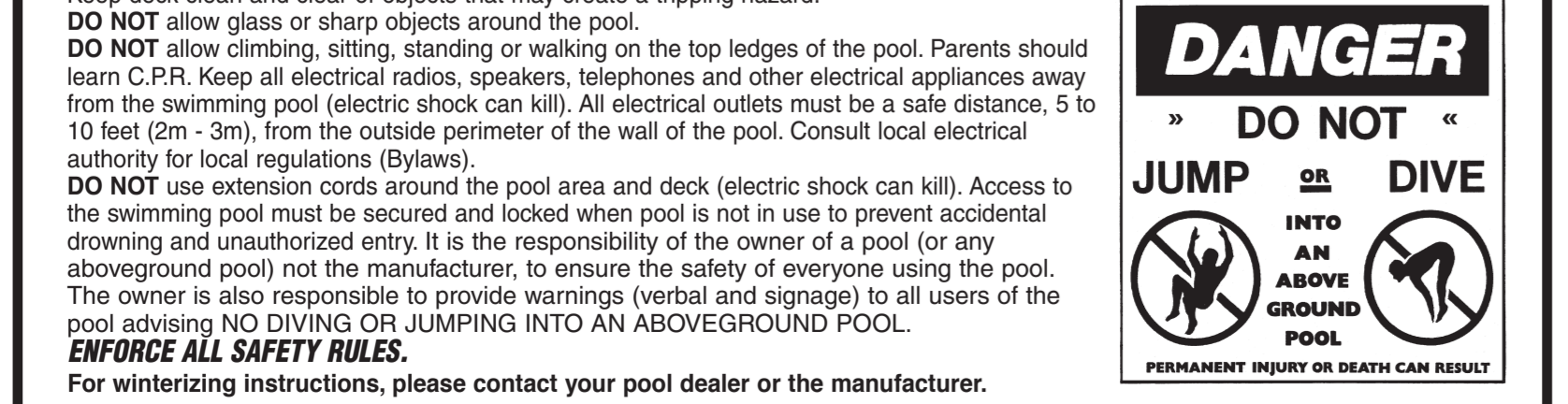

1. INSTALLATION DE VOTRE PISCINE HORS-SOL

Ces piscines doivent être installées seulement hors-sol et sur un sol ferme (non-craeus, non-remblayé). Ne faites aucun remplissage extérieur et n'entassez pas de terre au niveau des parois et des structures non plus.

- 2. COMMENT INSTALLER VOTRE PISCINE OVALE (en suivant les chiffres sur la feuille d'installation)
6 Outils requis.
7-18 Disposition, préparation du sol et mise à niveau du sol (dans les régions où le souchet comestible est courant (sud des États-Unis), stériliser le sol avec un produit chimique approuvé).

- 2. LISTE DE PIÈCES
6 Margelle, de 15 cm (82,87 cm) #6710-07 32 5/8" (82,87 cm)
7-18 Margelle, de 15 cm (123,51 cm) #6710-04 48 5/8" (123,51 cm)
19 Margelle, de 15 cm (119,06 cm) #6710-12 46 7/8" (119,06 cm)

* CES DIRECTIVES D'INSTALLATION SONT POUR UNE TOILE À CHEVAUCHEMENT. POUR D'AUTRES TYPES DE TOILES, CONSULTER LES DIRECTIVES DE LA BOÎTE DE LA TOILE.

3. PISCINE HORS-SOL LISTE DE PIÈCES

Table with columns for size, quantity, and part name. Includes items like Margelle, Poteau Vertical, and various connectors and tracks.

4. TAILLE DES PISCINES

Table showing actual dimensions for different pool sizes: 12' x 18', 12' x 24', 16' x 26', and 16' x 32'.

5. CONSIGNES DE SÉCURITÉ

NE PAS PLONGER, NE PAS SAUTER, EAU PEU PROFONDE. LES PISCINES PEUVENT CAUSER LA MORT, LA PARALYSIE OU DES BLESSURES IRRÉVERSIBLES. IL EST STRICTEMENT INTERDIT DE SAUTER ET DE PLONGER DANS UNE PISCINE OU DANS N'IMPORTE QUELLE PISCINE HORS-SOL.

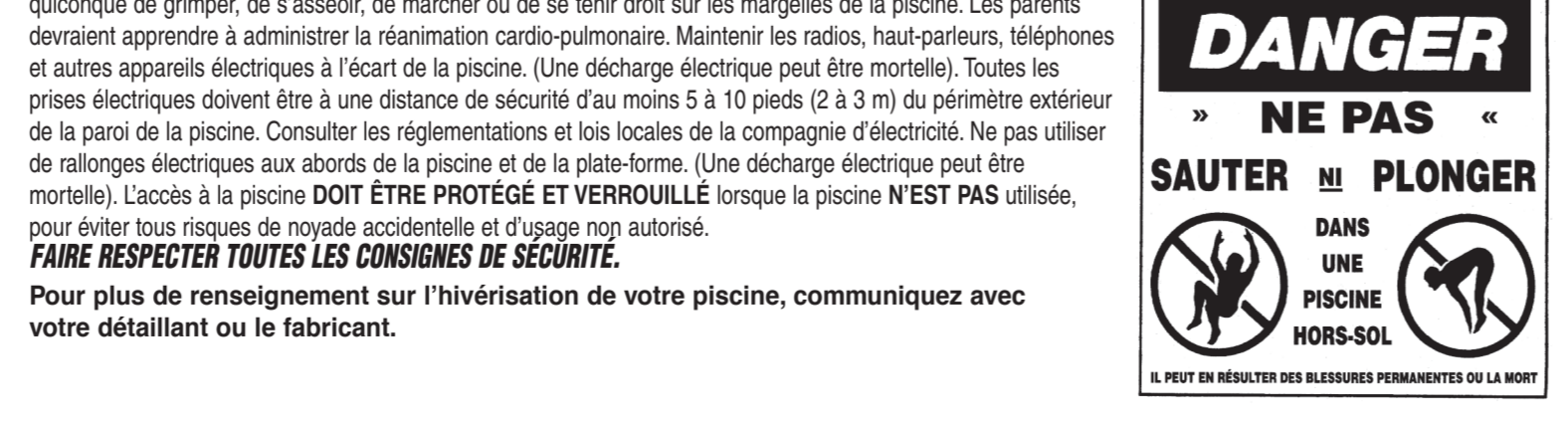

1. INSTALACIÓN DE SU PISCINA SOBRE TIERRA

Las piscinas se deben instalar solamente sobre terreno nivelado y firme (no excavado, ni rellenado). Nosotros no recomendamos rellenar o terraplenar con tierra contra las paredes o estructuras de la piscina cubriendo alguna de sus partes.

- 2. PASOS PARA INSTALAR SU PISCINA OVALADA (números siguientes en el folleto de instalación)
6 Herramientas requeridas.
7-18 Demarcación, preparación y nivelación del terreno (en áreas propensas a la cutufa (sur de los Estados Unidos), esterilice la tierra con productos químicos aprobados).

- 2. LISTA DE PIEZAS PARA LA PISCINA SOBRE TIERRA
6 Borde de 6 pulg. (15 cm) #6710-07 32 5/8 pulg. (82,87 cm)
7-18 Borde de 6 pulg. (15 cm) #6710-04 48 5/8 pulg. (123,51 cm)
19 Borde de 6 pulg. (15 cm) #6710-12 46 7/8 pulg. (119,06 cm)

* ESTA INSTRUCCIONES SON PARA UNA TELA DE IMBRICACIÓN. PARA OTROS TIPOS DE TELAS, CONSULTAR A LOS INSTRUCCIONES DE LA CAJA DE LA TELA.

3. LISTA DE PIEZAS PARA LA PISCINA SOBRE TIERRA

Table with columns for size, quantity, and part name. Includes items like Borde, Poste Vertical, and various connectors and tracks.

4. MEDIDA REAL

Table showing actual dimensions for different pool sizes: 12' x 18', 12' x 24', 16' x 26', and 16' x 32'.

5. CONSIDERACIONES DE SEGURIDAD

NO ZAMBULLIRSE, NO SALTAR, AGUA DE POCA PROFUNDIDAD. EL ZAMBULLIRSE PUEDE CAUSAR MUERTE, PARALISIS O LESIONES PERMANENTES. El saltar o zambullirse dentro de una piscina o cualquiera piscina sobre tierra está estrictamente prohibido.

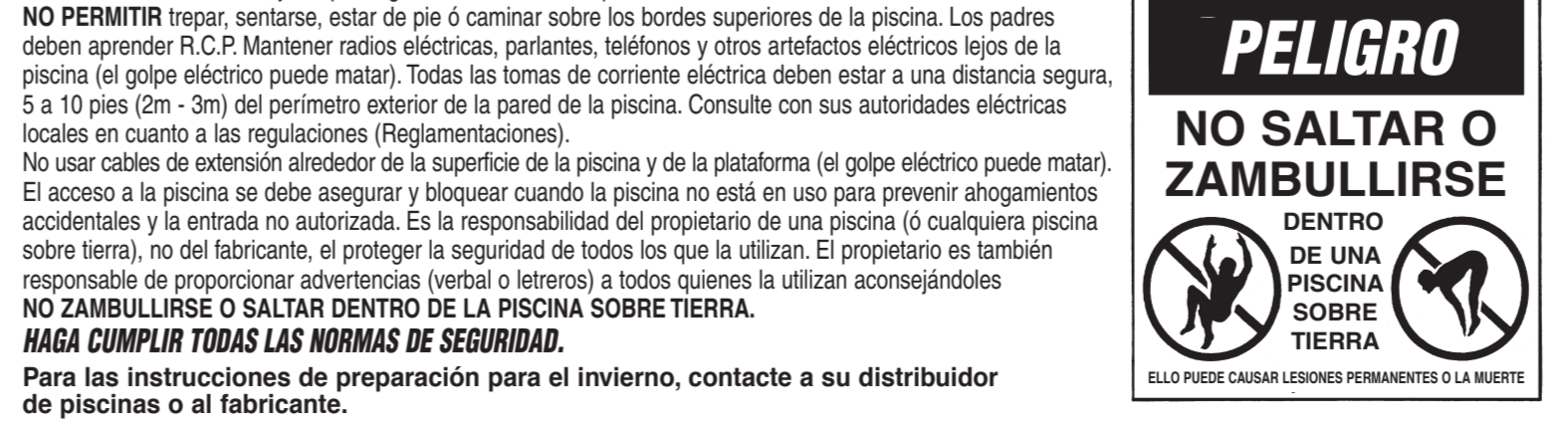

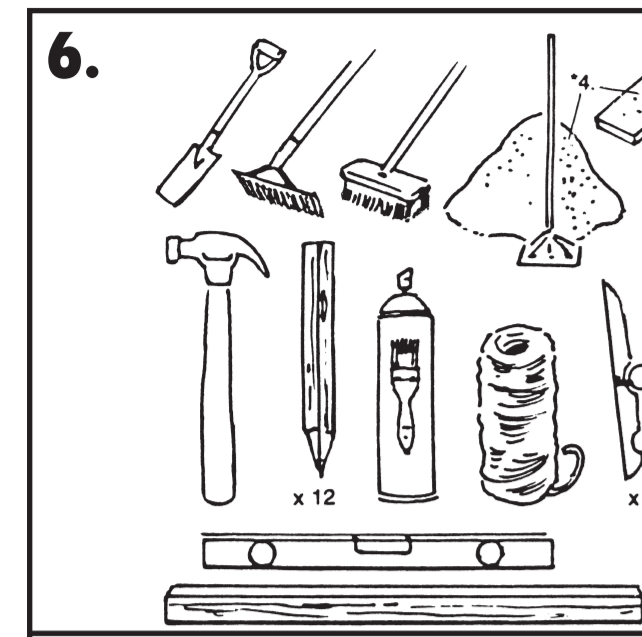
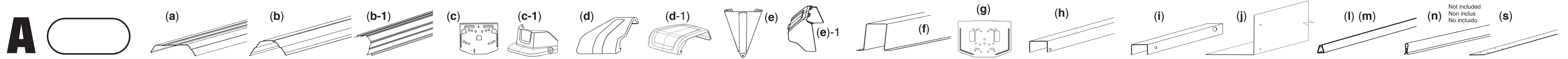

	A	B	C	D
12' x 18'	5'-6"	6'-1/2"	12'-1"	13'-3"
12' x 24'	11'-0"	6'-1/2"	12'-1"	16'-4"
16' x 26'	11'-0"	8'-1/4"	16'-1/2"	19'-5 1/2"
16' x 32'	16'-6"	8'-1/4"	16'-1/2"	23'
5,60m x 3,70m	1,68m	1,84m	3,68m	4,04m
7,30m x 3,70m	3,36m	1,84m	3,68m	4,98m
7,30m x 5,00m	3,36m	2,45m	4,89m	5,93m
8,05m x 4,90m	3,36m	2,45m	4,89m	5,93m
9,80m x 4,90m	5,03m	2,45m	4,89m	7,02m

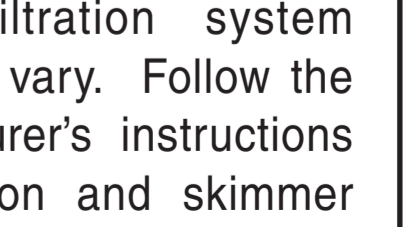
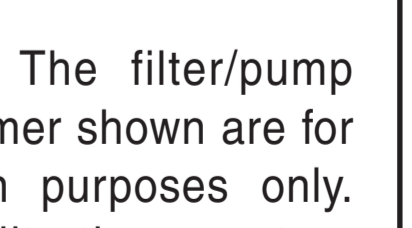
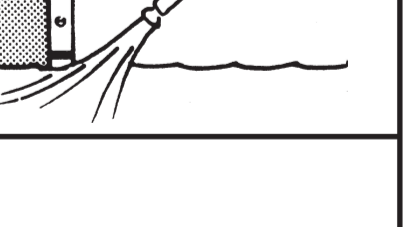
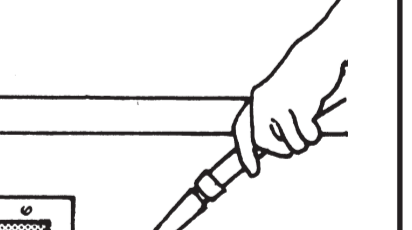
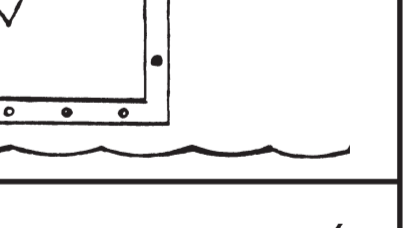
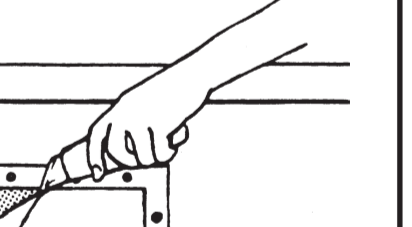
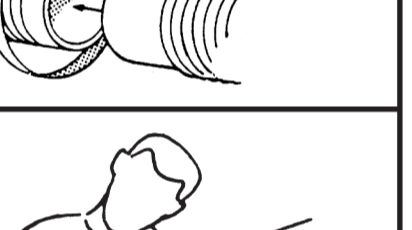
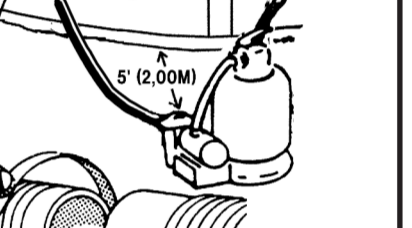
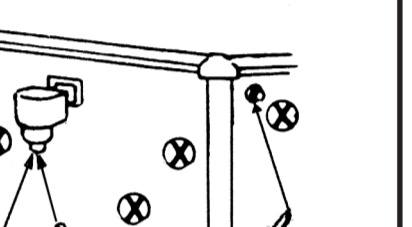
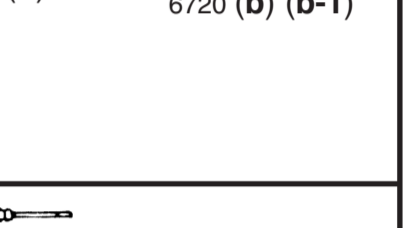
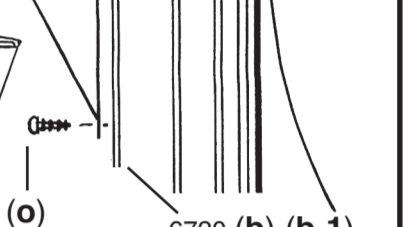
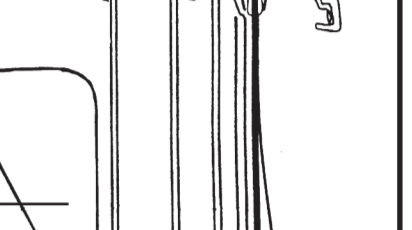
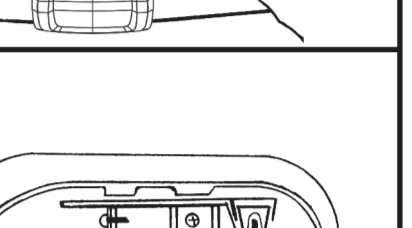
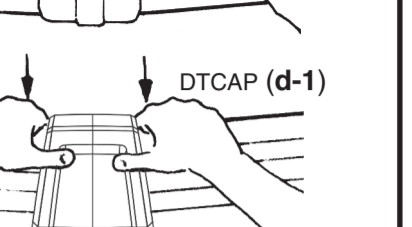
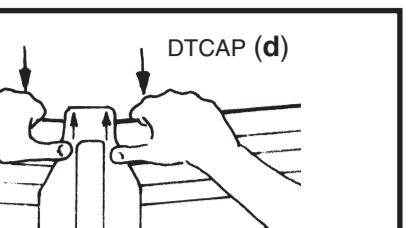
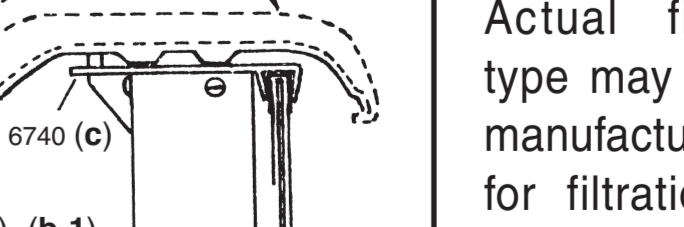
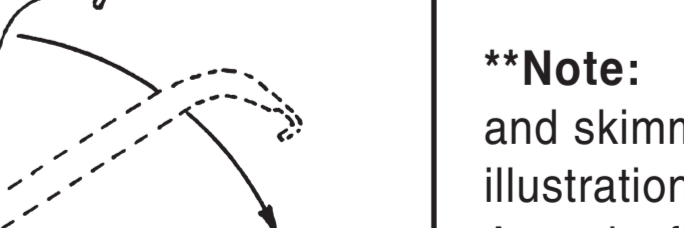
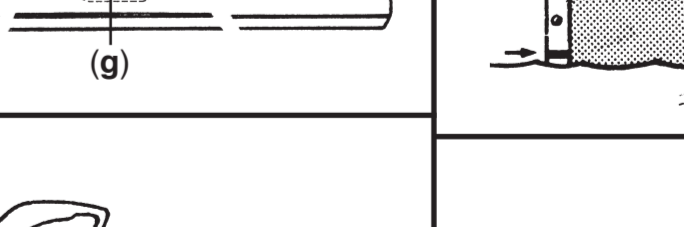
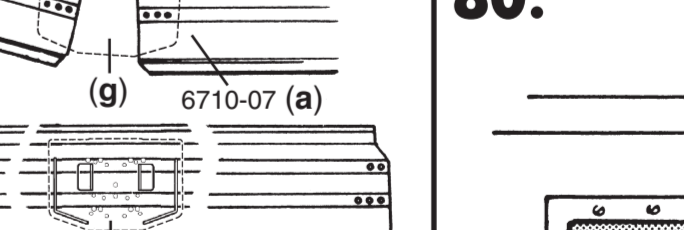
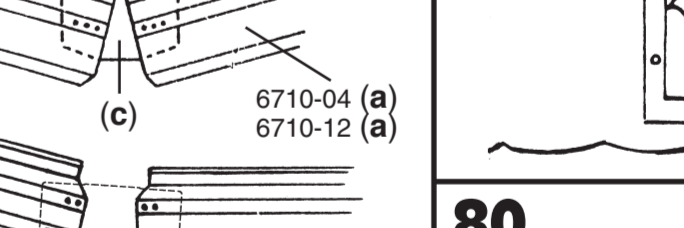
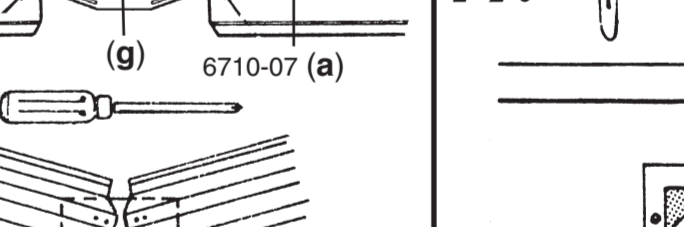
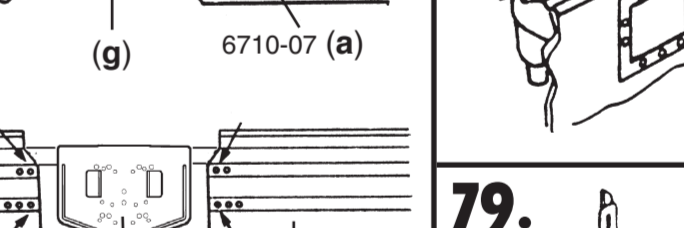
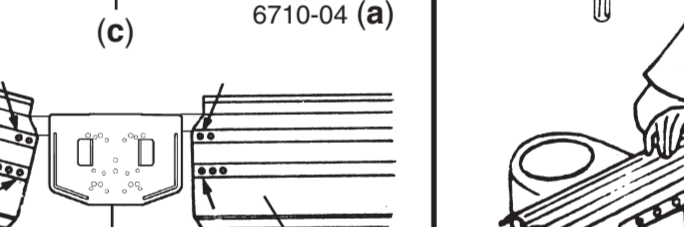
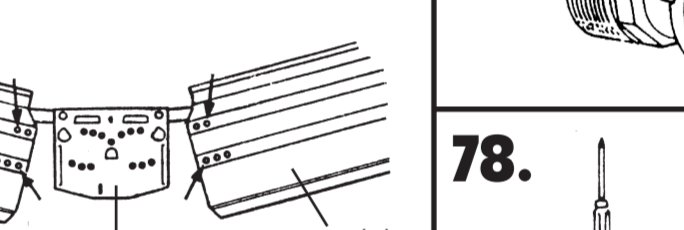
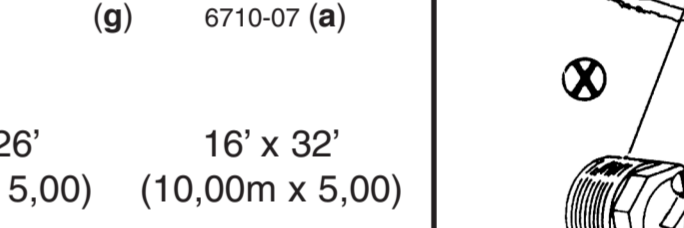
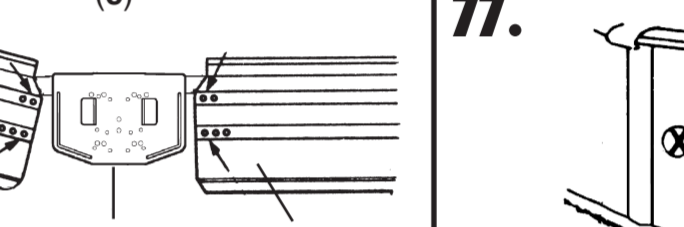
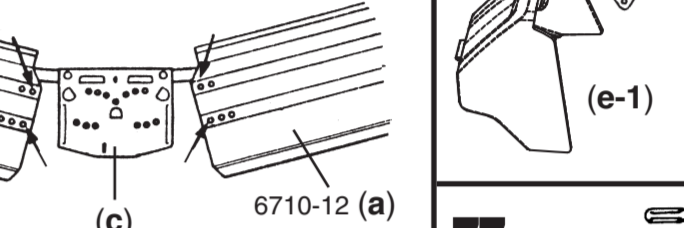
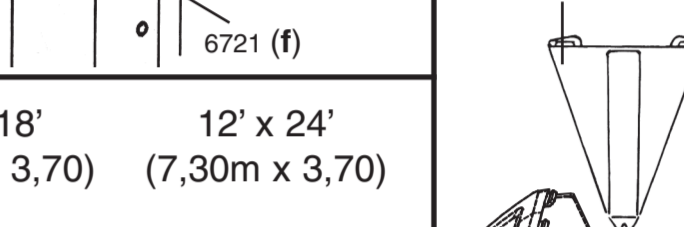
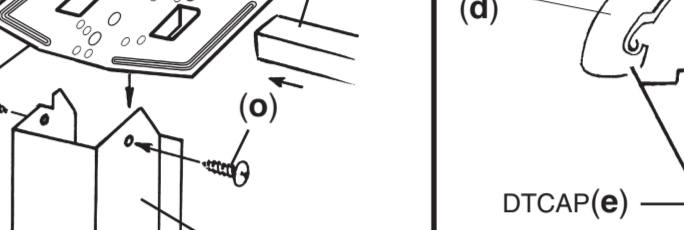
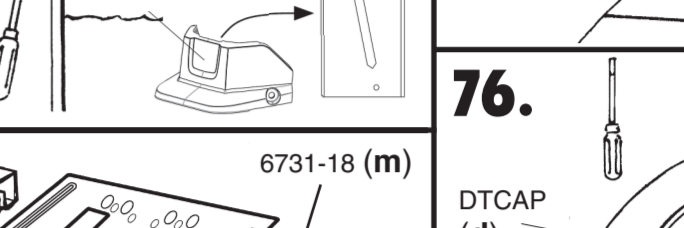
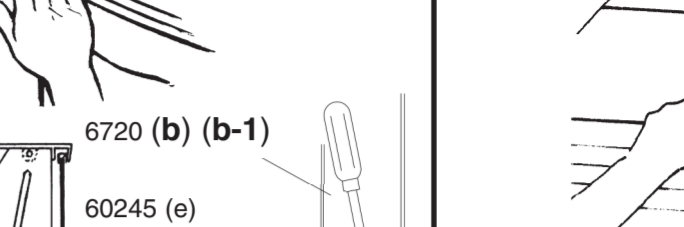
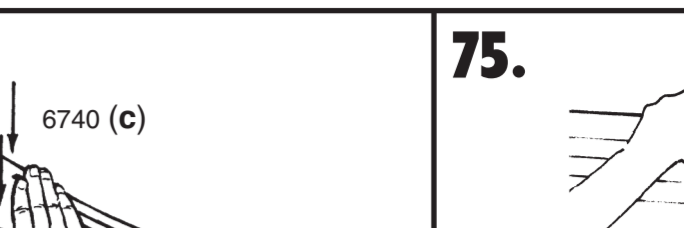
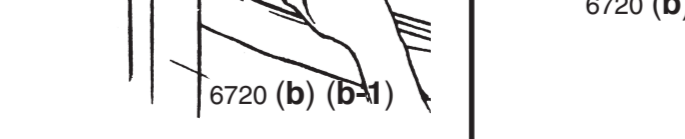
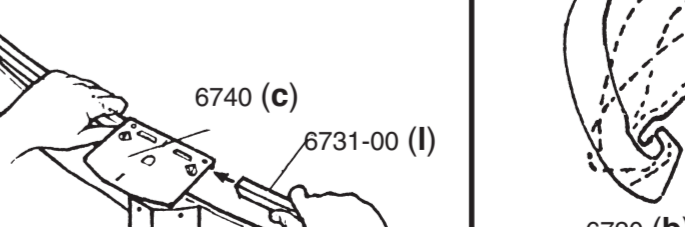
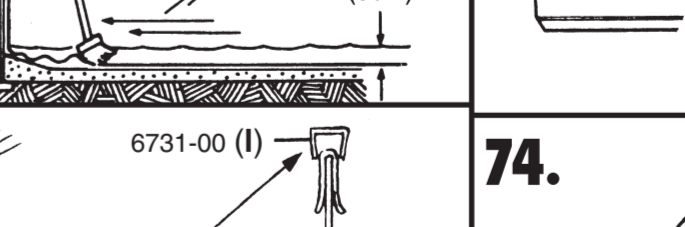
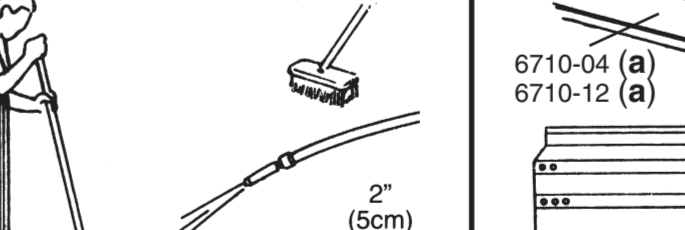
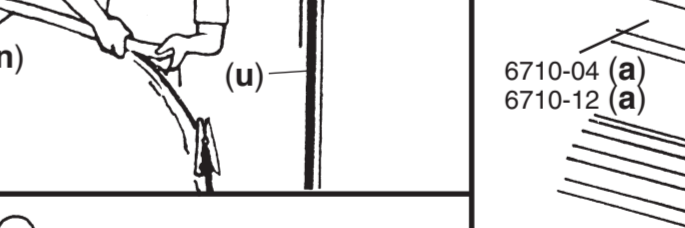
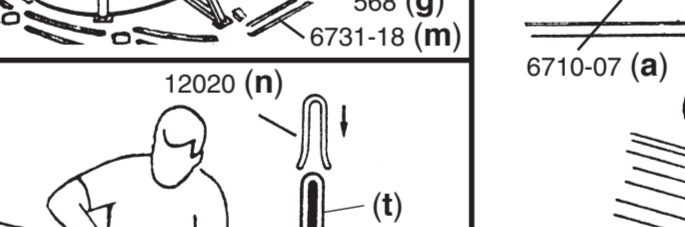
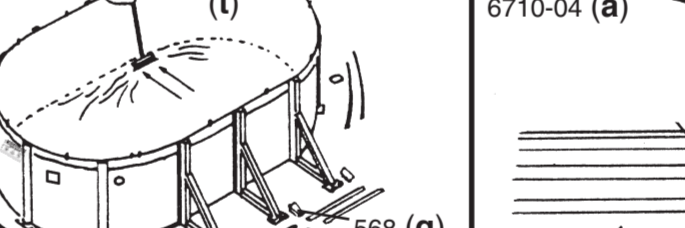
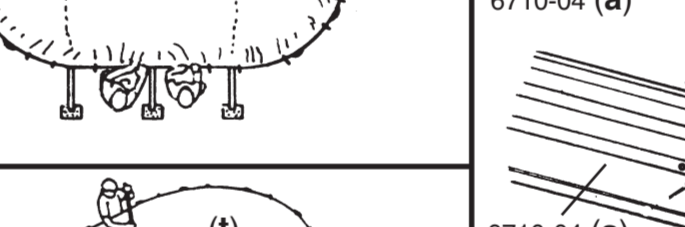
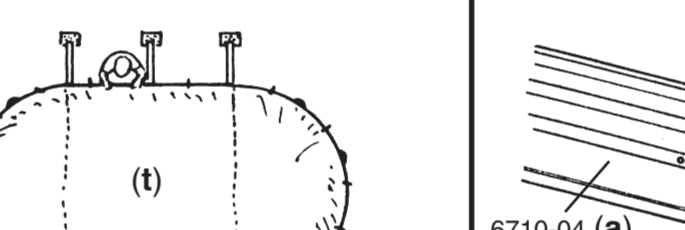
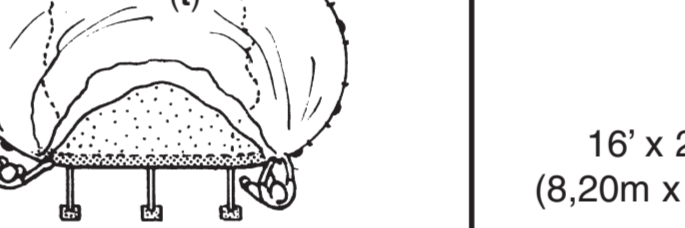
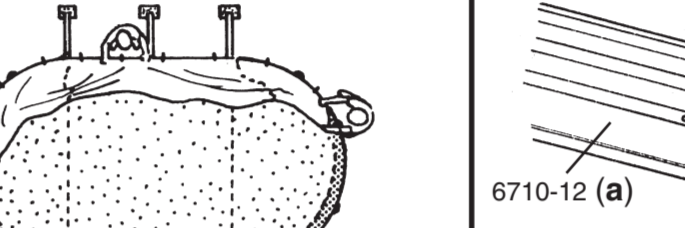
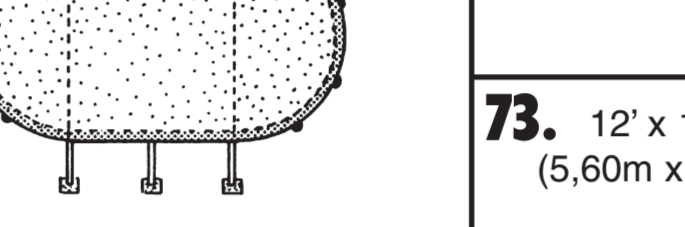
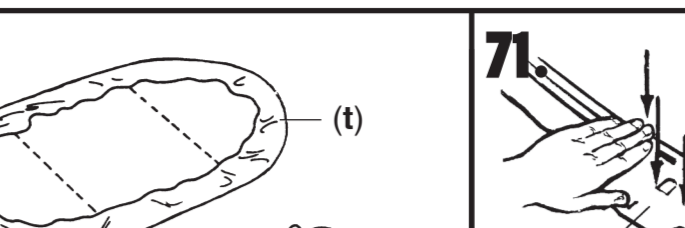
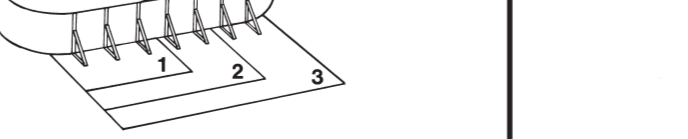
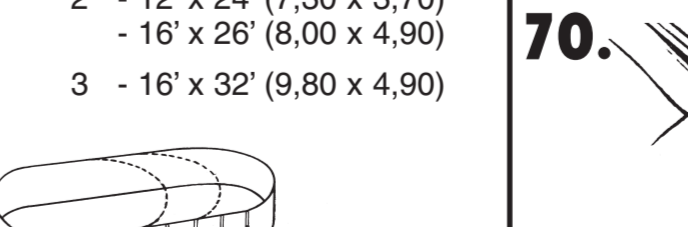
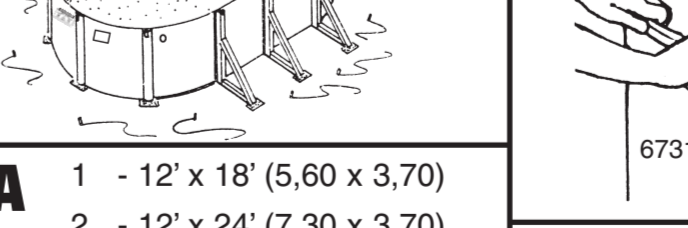
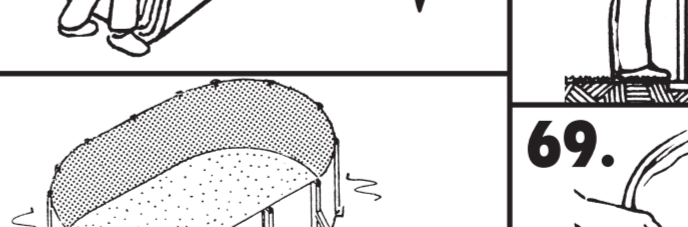
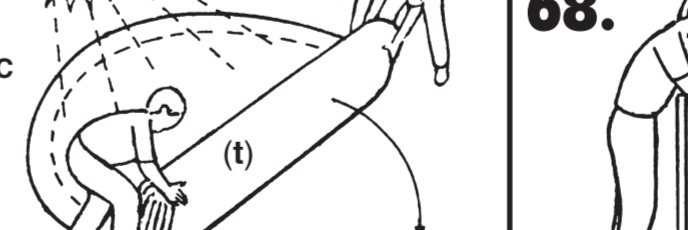
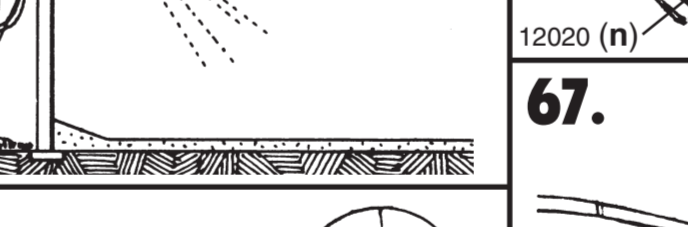
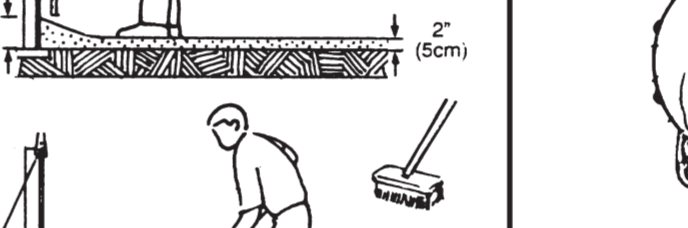
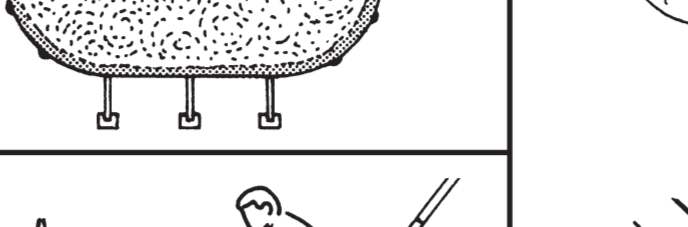
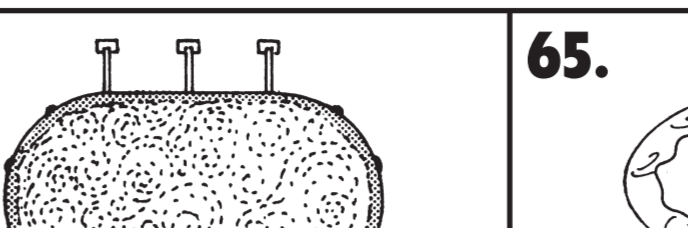
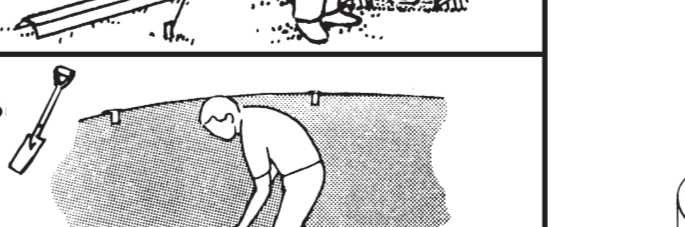
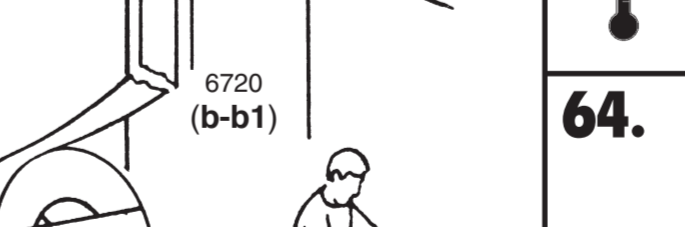
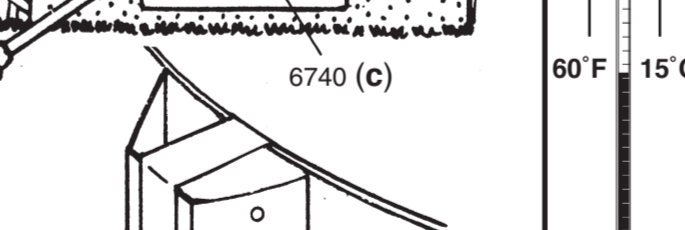
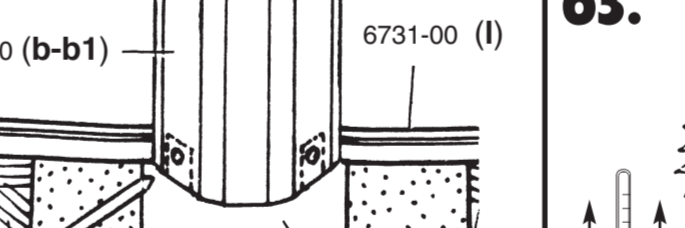
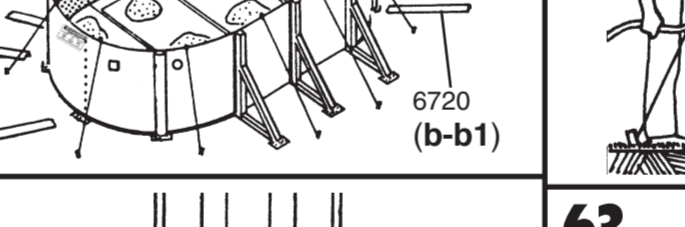
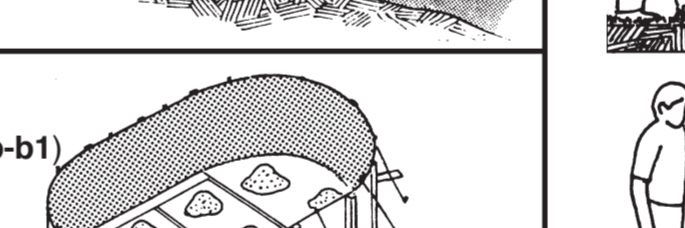
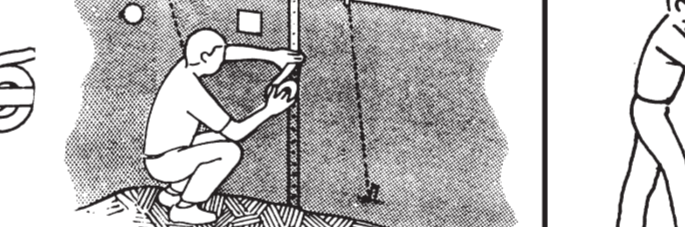
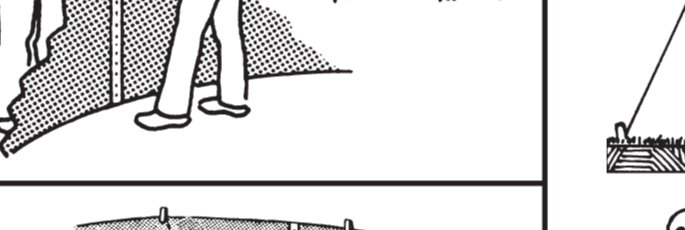
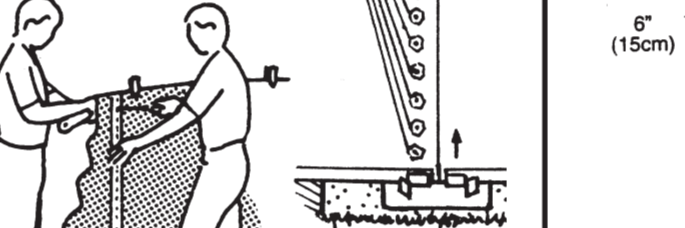
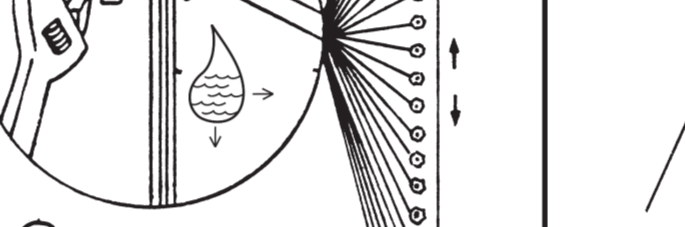
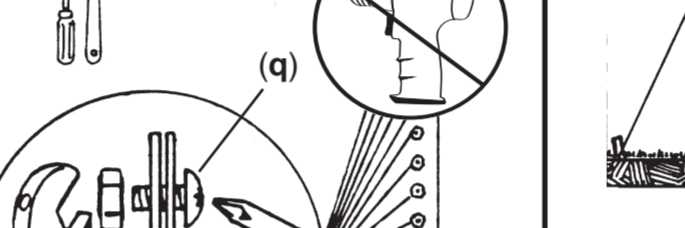
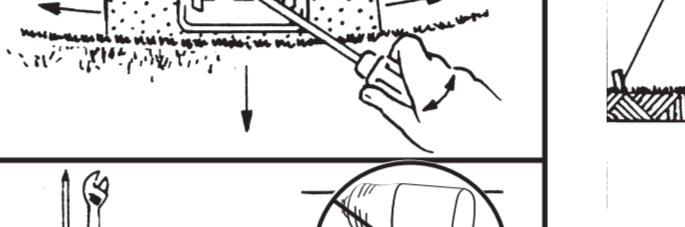
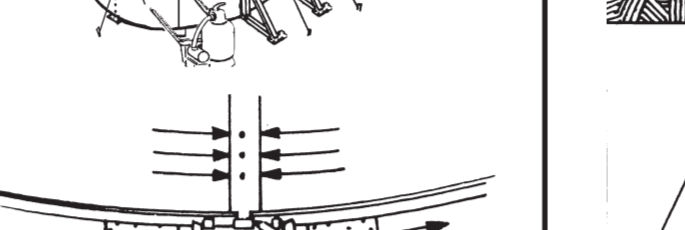
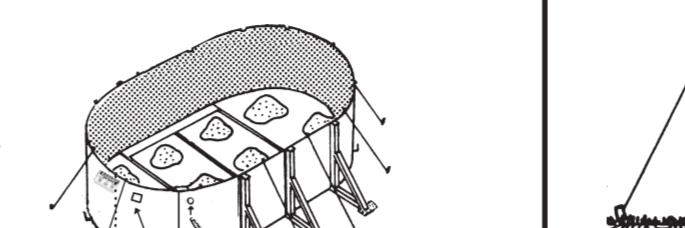
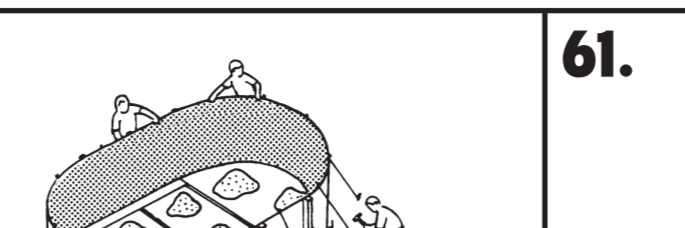
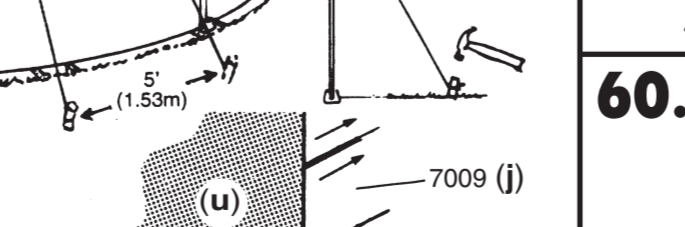
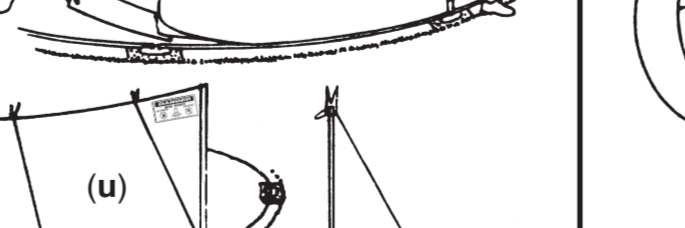
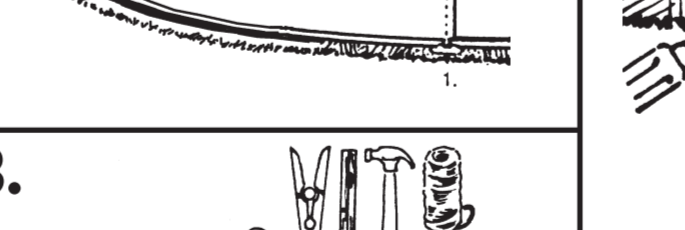
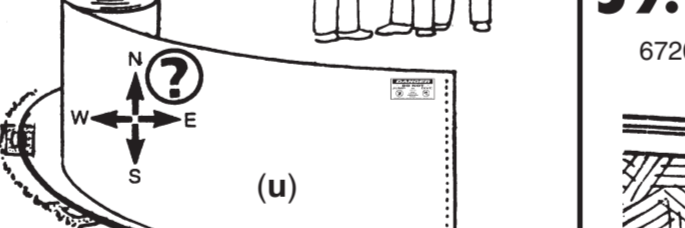
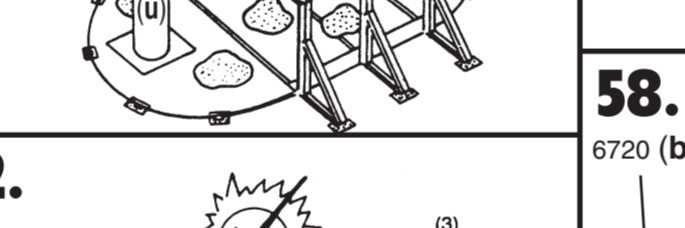
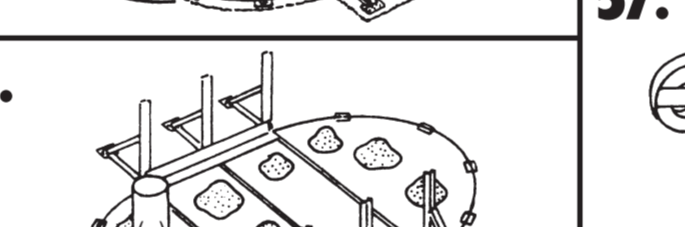
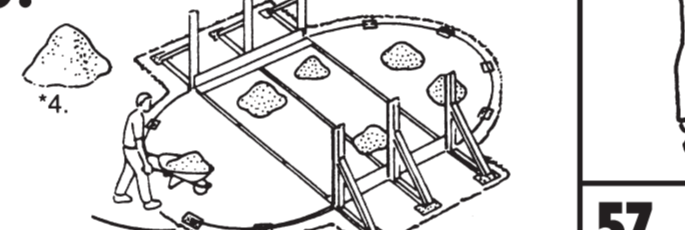
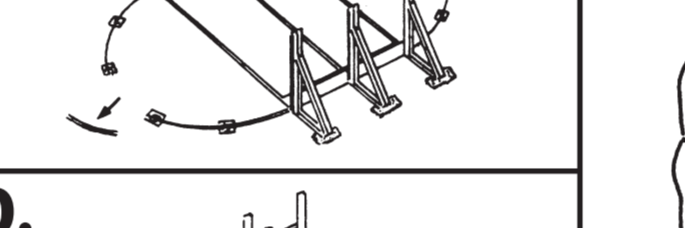
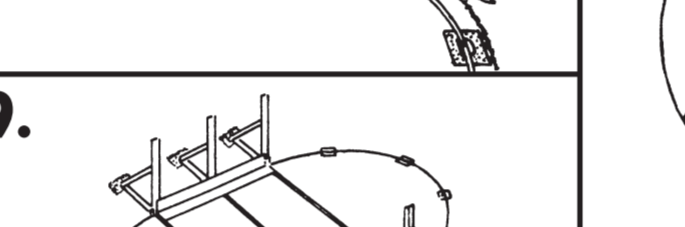
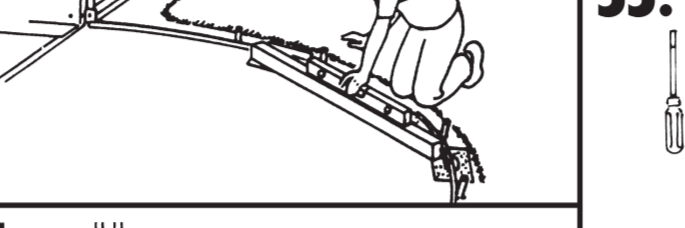
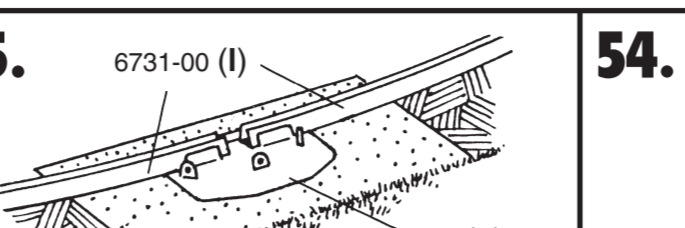
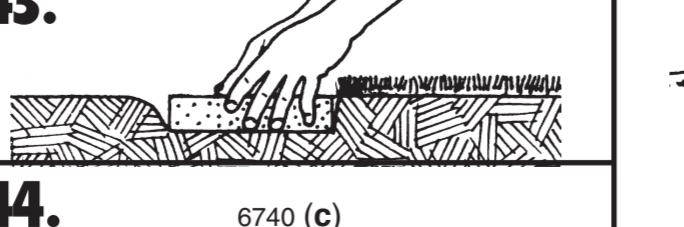
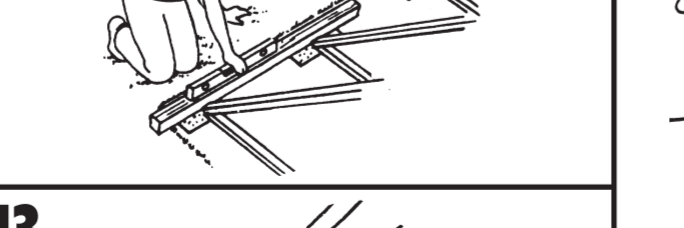
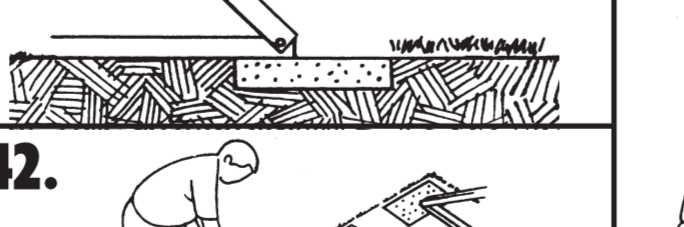
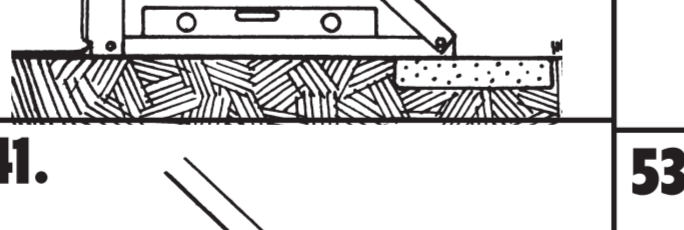
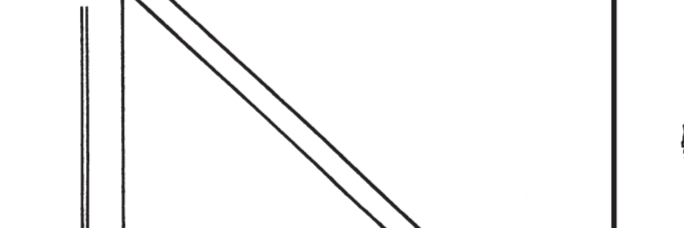
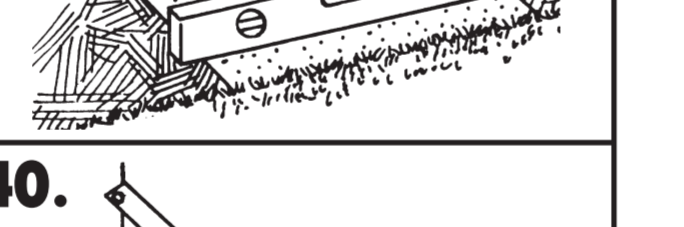
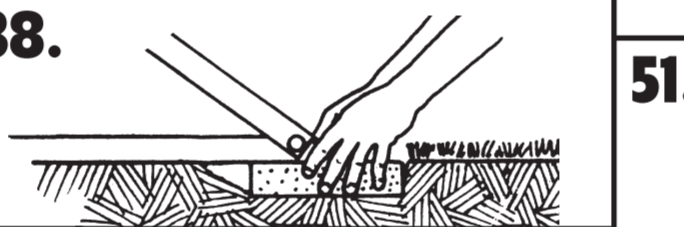
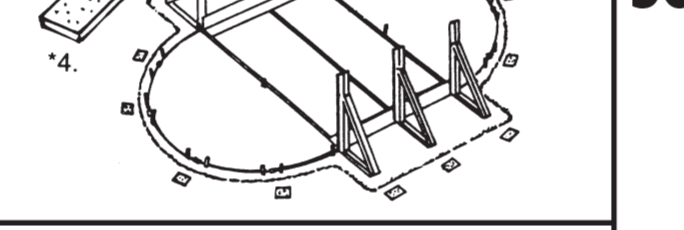
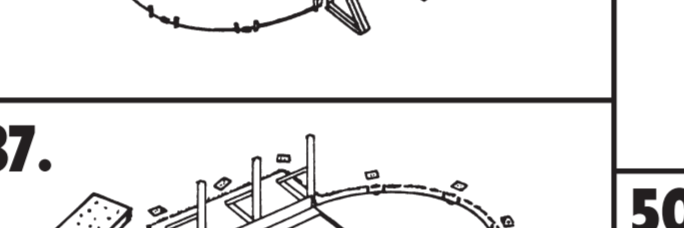
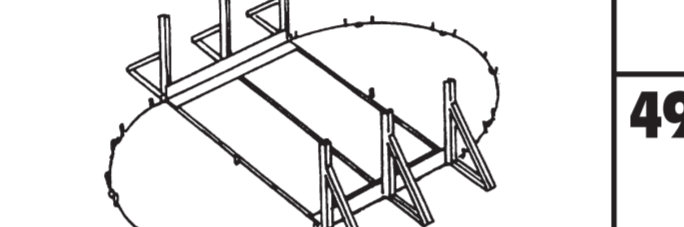
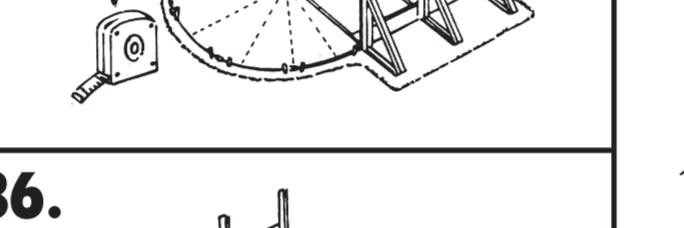
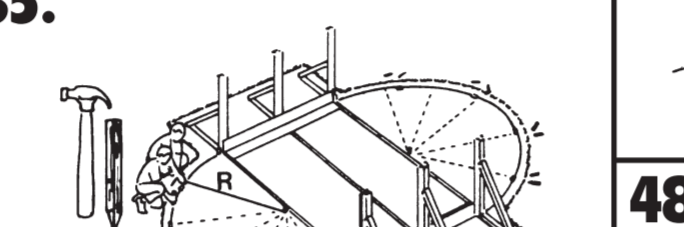
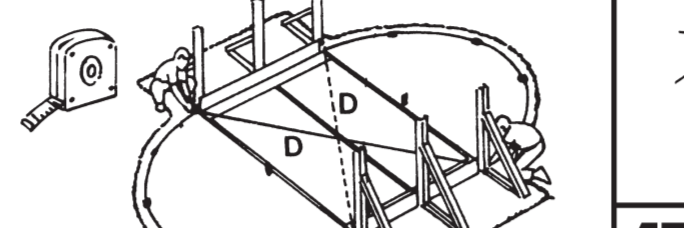
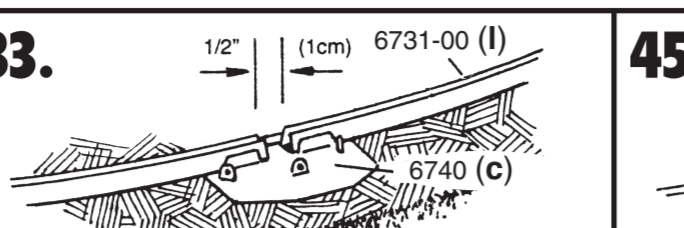
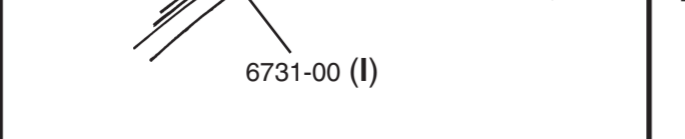
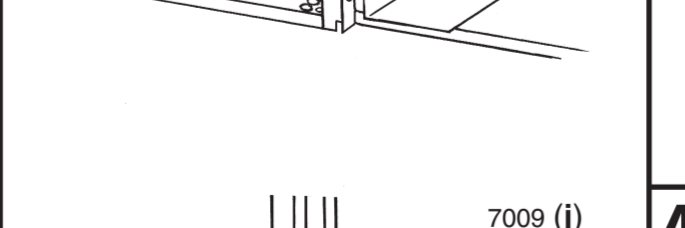
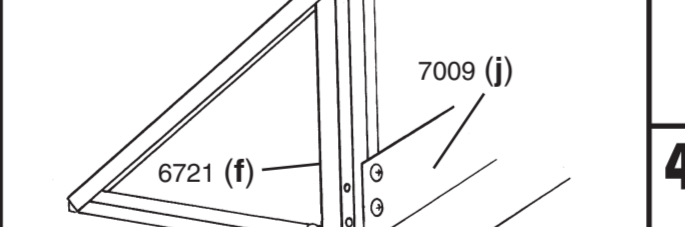
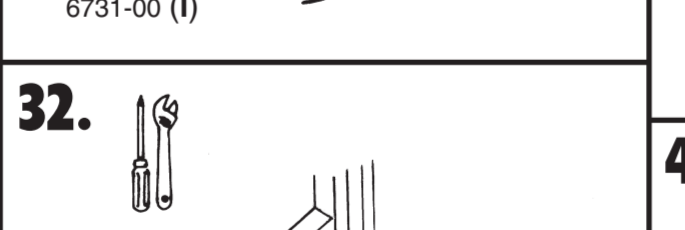
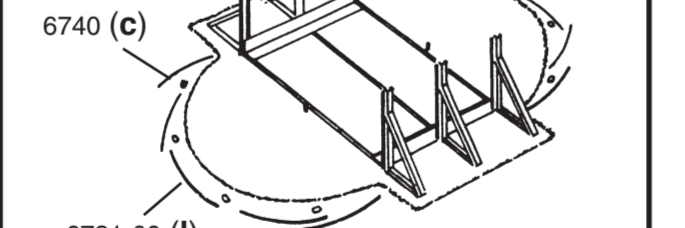
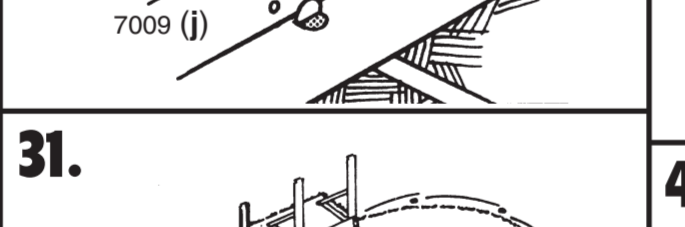
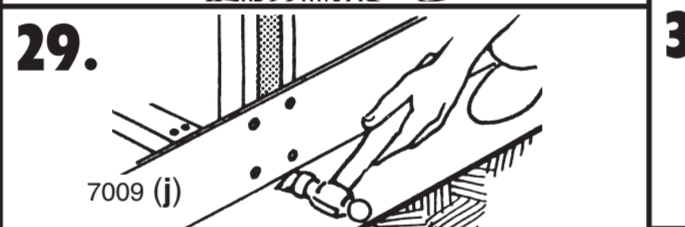
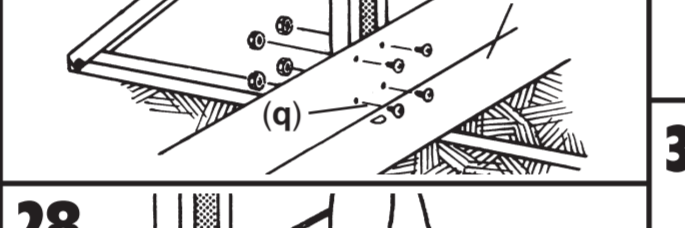
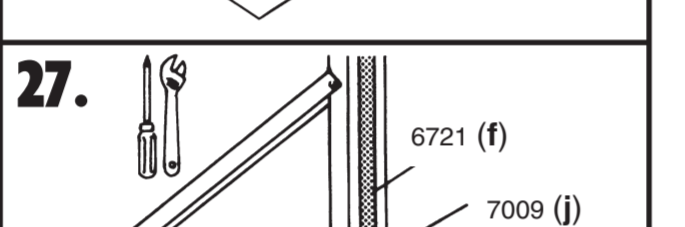
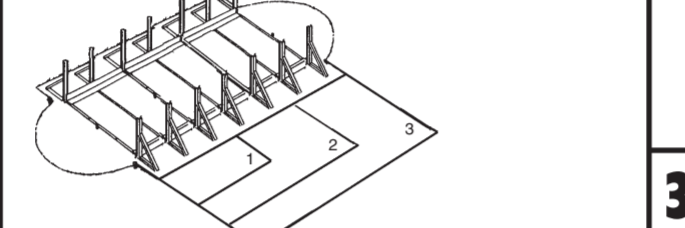
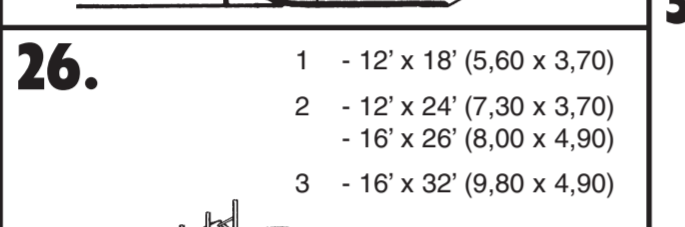
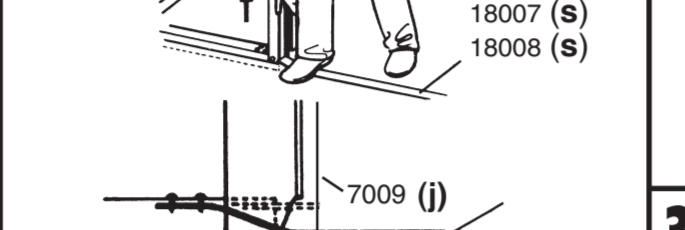
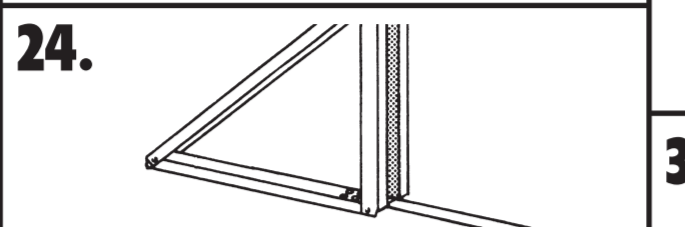
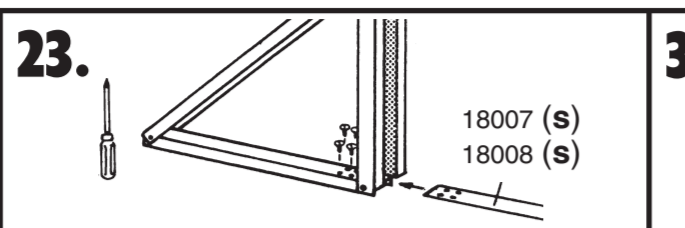
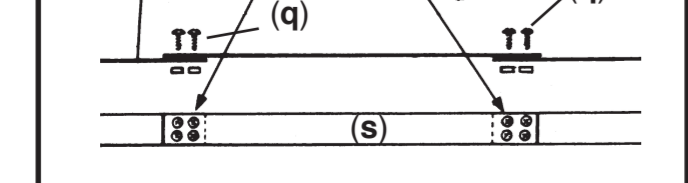
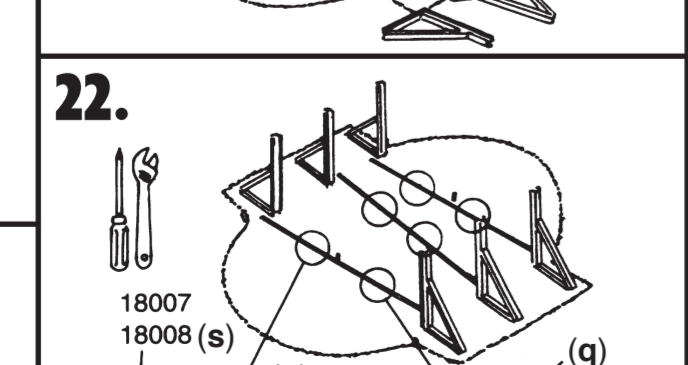
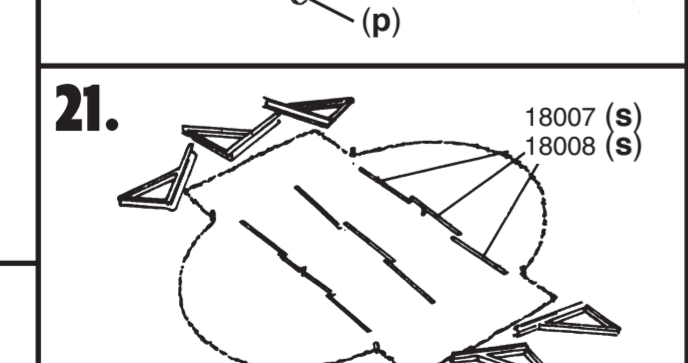
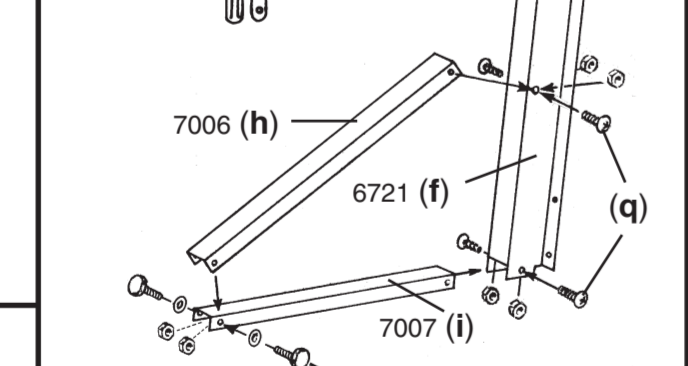
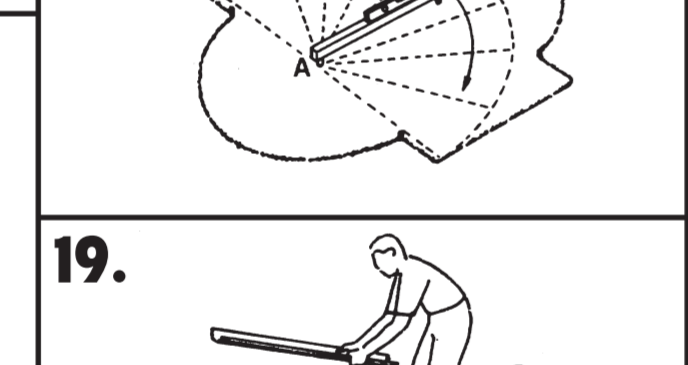
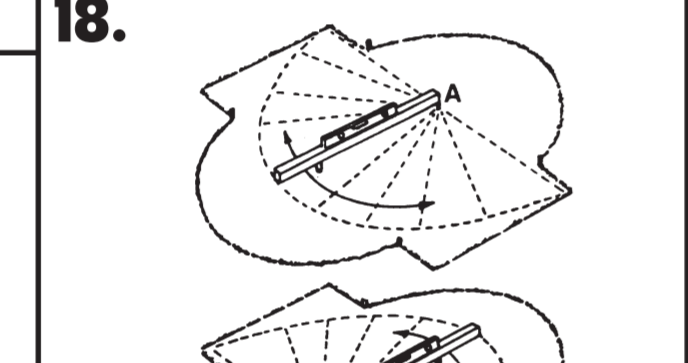
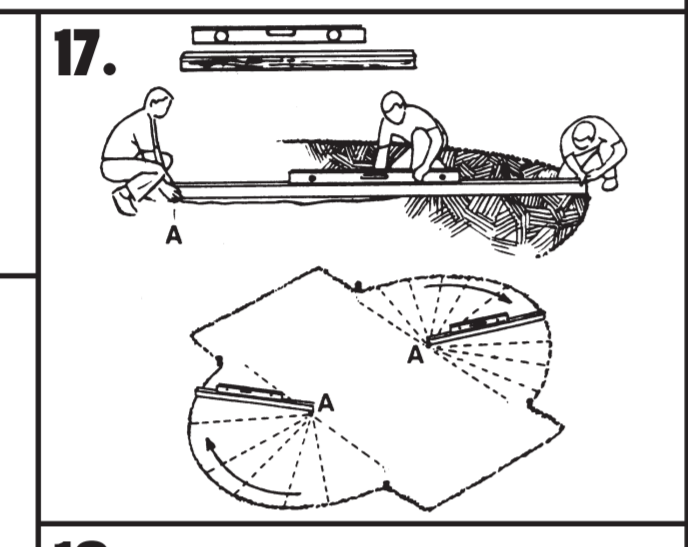
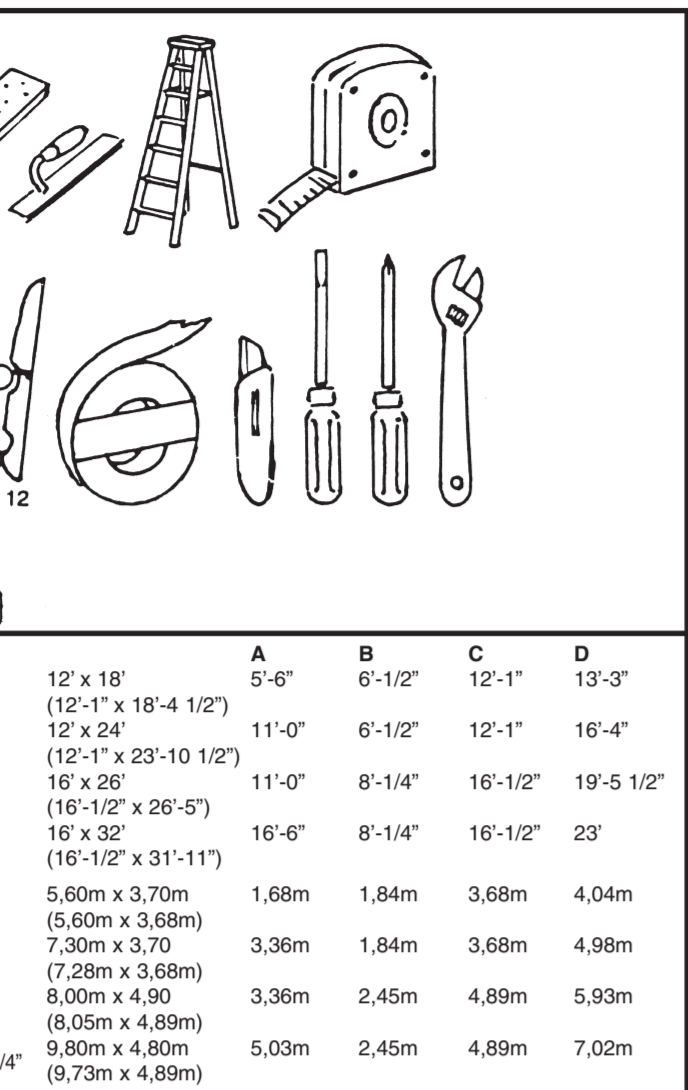
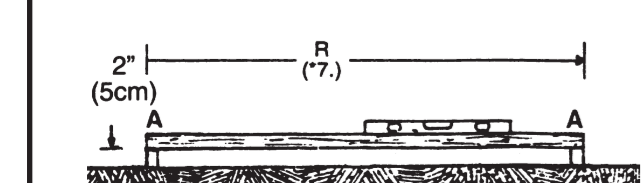
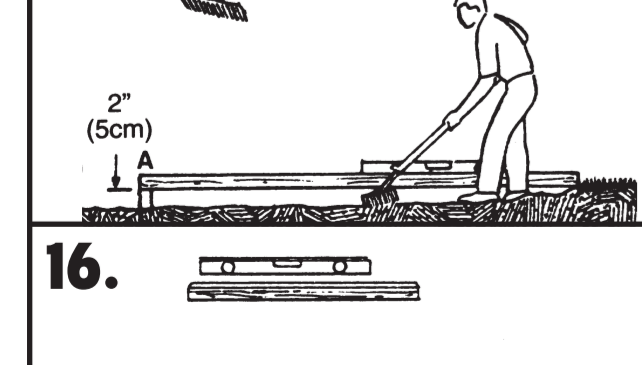
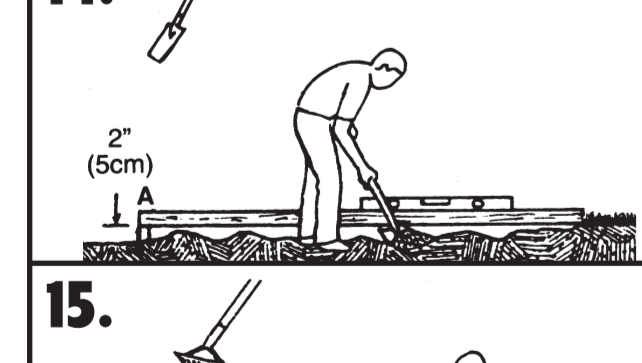
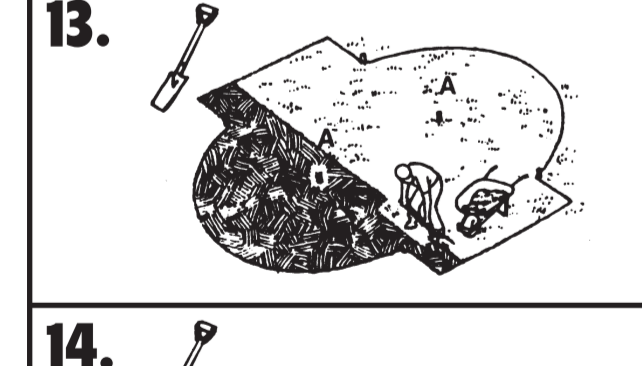
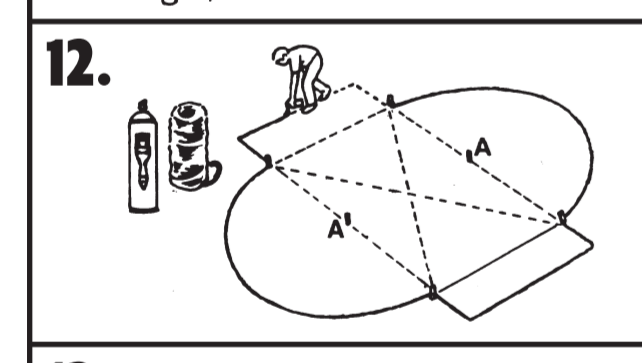
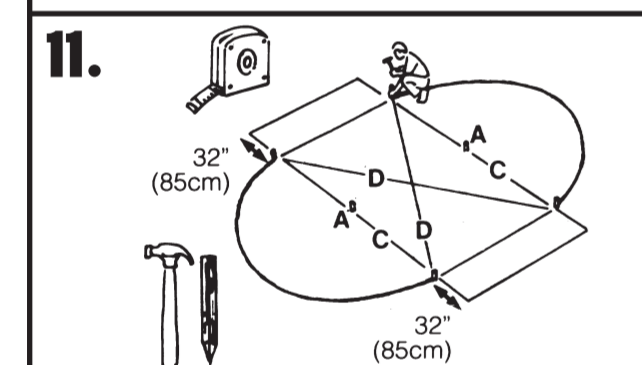
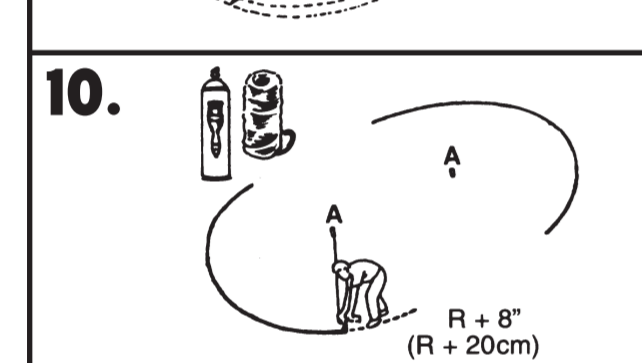
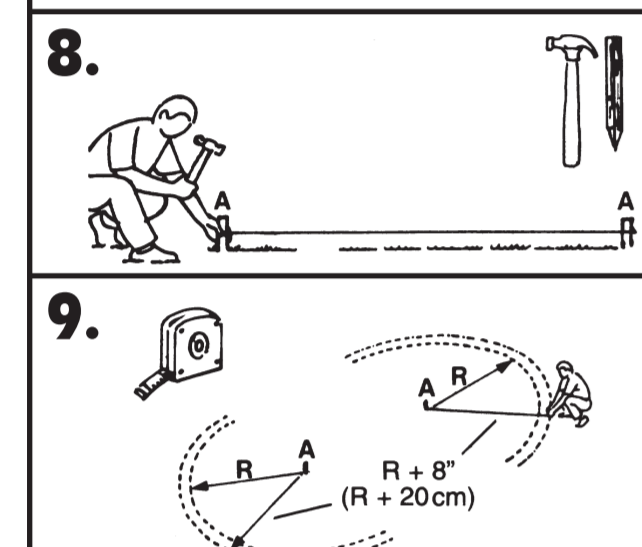

****Note:** The filter/pump and skimmer shown are for illustration purposes only. Actual filtration system type may vary. Follow the manufacturer's instructions for filtration and skimmer hook-up.