

SIDEKICK TABLETOP SOCCER ASSEMBLY INSTRUCTIONS



NG1028T3



















THANK YOU!

Thank you for purchasing this product.

We work around the clock and around the globe to ensure that our products maintain the highest possible quality. However, in the rare instance that your product is defective or missing parts, contact your retailer, or call 800-759-0977, to submit parts requests or warranty claims. Please read the warranty information at the back of these assembly instructions for further details.

**IMPORTANT! PLEASE READ THESE ASSEMBLY INSTRUCTIONS
IN ENTIRETY BEFORE ASSEMBLING YOUR PRODUCT.**

PARTS IDENTIFIER (NOT TO SCALE)

#1  BOLT 8 pcs	#2  FLAT WASHER 8 pcs	#3  1-1/2" SCREW 4 pcs	#4  1/2" SCREW 24 pcs	#5  TWO-PIECE GOAL 2 pcs
#6  HEX WRENCH 1 pcs	#7  SIDE PANEL 2 pcs	#8  END PANEL 2 pcs	#9  PLAYFIELD 1 pcs	#10  LEG 4 pcs
#11  SOCCER BALL 2 pcs	#12  HAND GRIP 6 pcs	#13  ORANGE PLAYER RODS 3 pcs	#14  BLUE PLAYER RODS 3 pcs	#15  ROD END CAP 6 pcs
#16  PLAYFIELD SUPPORT 2 pcs	#17  CORNER 4 pcs	#18  FOAM BUMPER 12 pcs	#19  PLASTIC ROD WASHER 12 pcs	

ADDITIONAL EQUIPMENT REQUIRED:



*Please see Parts List at end of manual for part number when ordering parts.
For replacement parts please call 800-759-0977.*

ASSEMBLY TIPS

1. Find a clean, level surface to begin the assembly of your game table. The table will be partially assembled upside down and then turned over onto its legs. This is a heavy game and turning it over will require at least two strong adults.
2. Remove all of the contents from box and verify that you have all of the parts shown on the Parts Identifier before you begin assembly. **Note: Some parts may be pre-installed or pre-assembled.**
3. Some figures or drawings may not look exactly like your product. Please read and understand the text before beginning each assembly step.
4. **When installing parts that have more than one screw or bolt, hand tighten all screws or bolts in place before final tightening with screwdriver or hex wrench.**
5. Electric screwdrivers may be helpful during assembly; however, please set a **low torque** and use extreme caution because screws may be stripped or overtightened, resulting in damaged parts, if the electric screwdriver's torque is set too high.

WARNINGS!

READ AND FOLLOW ALL ASSEMBLY, OPERATION AND SAFETY INSTRUCTIONS CAREFULLY.

**CHOKER HAZARD - THIS TABLE CONTAINS SMALL BALLS AND PARTS
NOT SUITABLE FOR CHILDREN UNDER 3 YEARS OF AGE.**

ASSEMBLY INSTRUCTIONS

1. Attach one SIDE PANEL #7 to the end of each END PANEL #8 by sliding one CORNER #17 down onto each end and securing with 1/2" SCREW #4. *Note: The table is shown assembled upside down.*

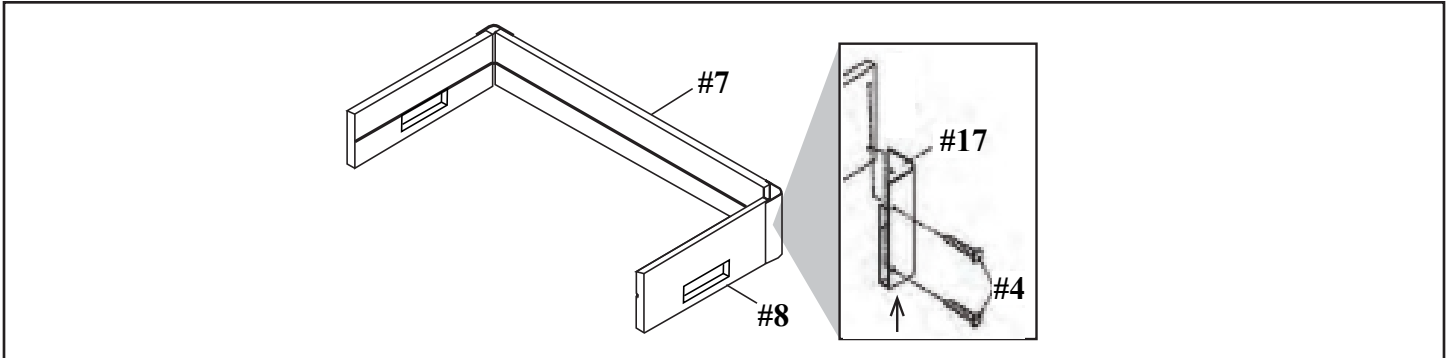

2. Slide PLAYFIELD #9, with field markings face down, into the END PANEL grooves. *Note: Playfield will also fit into grooves on both Side Panels once fully assembled.*

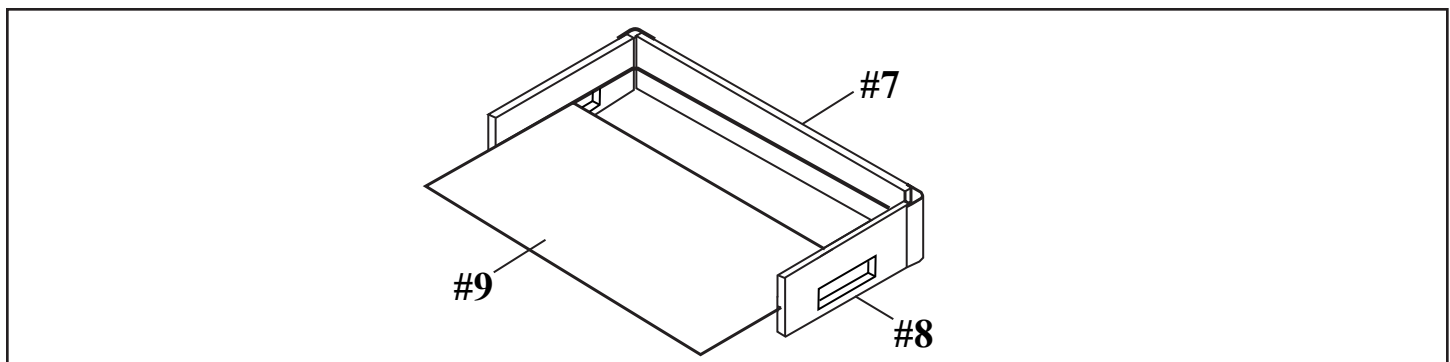

3. Insert pre-assembled ORANGE PLAYER RODS #13 and BLUE PLAYER RODS #14 into one SIDE PANEL #7 as shown below. *Note: To avoid confusion, it may be helpful to lay out the PLAYER RODS in their correct order and orientation BEFORE inserting them into SIDE PANEL.* Although this table is assembled upside down, players are shown upright, and other SIDE PANEL and END PANELS are NOT shown, for clarity. Each team should face the opposite goal when table is turned over (the visible screw head indicates the front of the player). Make sure the FOAM BUMPERS #18 and PLASTIC ROD WASHERS #19 are in place before inserting rods into SIDE PANELS.

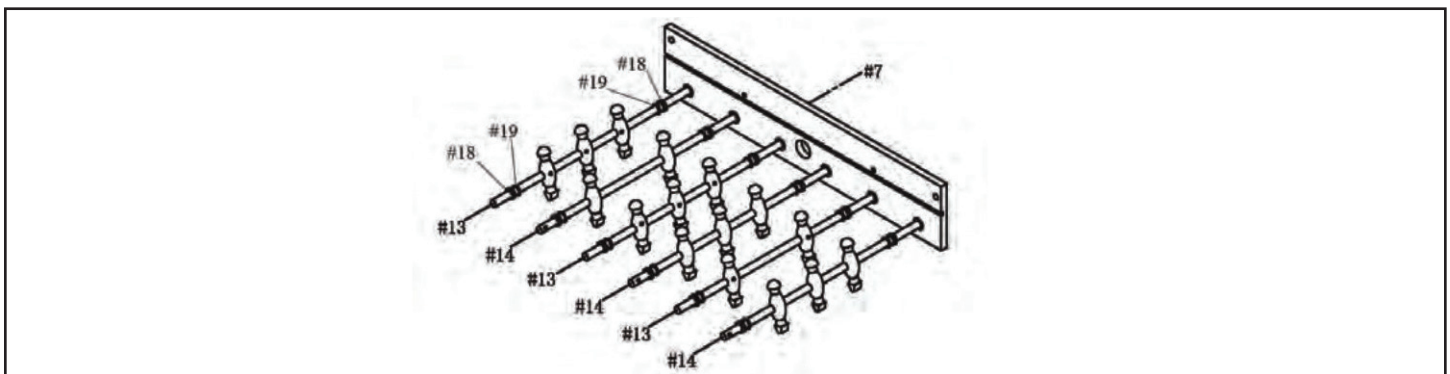

4. Insert PLAYER RODS through holes on other SIDE PANEL and attach to each END PANEL with CORNER #17 and 1/2" SCREW #4 as you did in step 1.

ASSEMBLY INSTRUCTIONS (CONT.)

5. Attach two PLAYFIELD SUPPORT BRACE #16 underneath PLAYFIELD by fastening to SIDE PANELS with 1-1/2" SCREW #3.

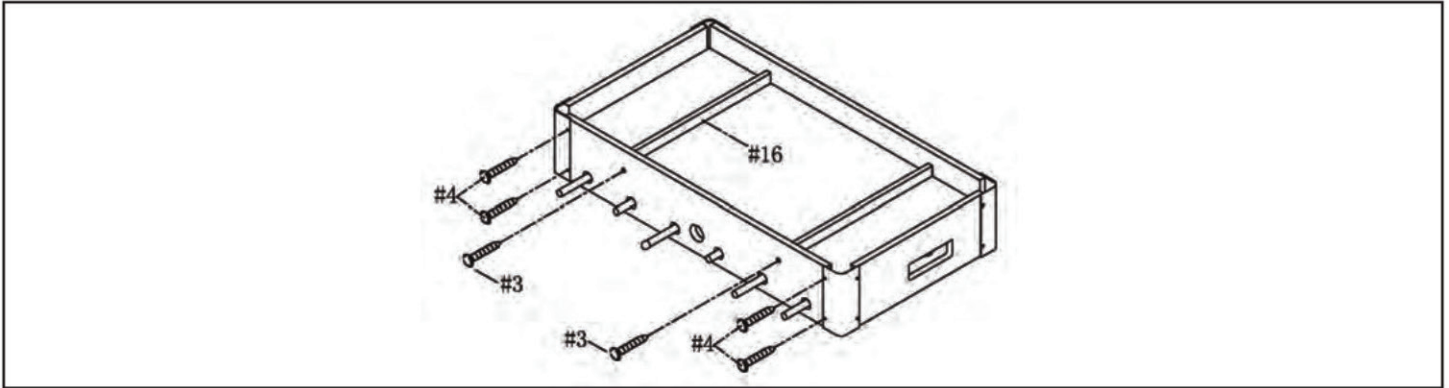

6. Attach one LEG #10 to each corner of the table using BOLT#1 and FLAT WASHER #2. Carefully turn table over.

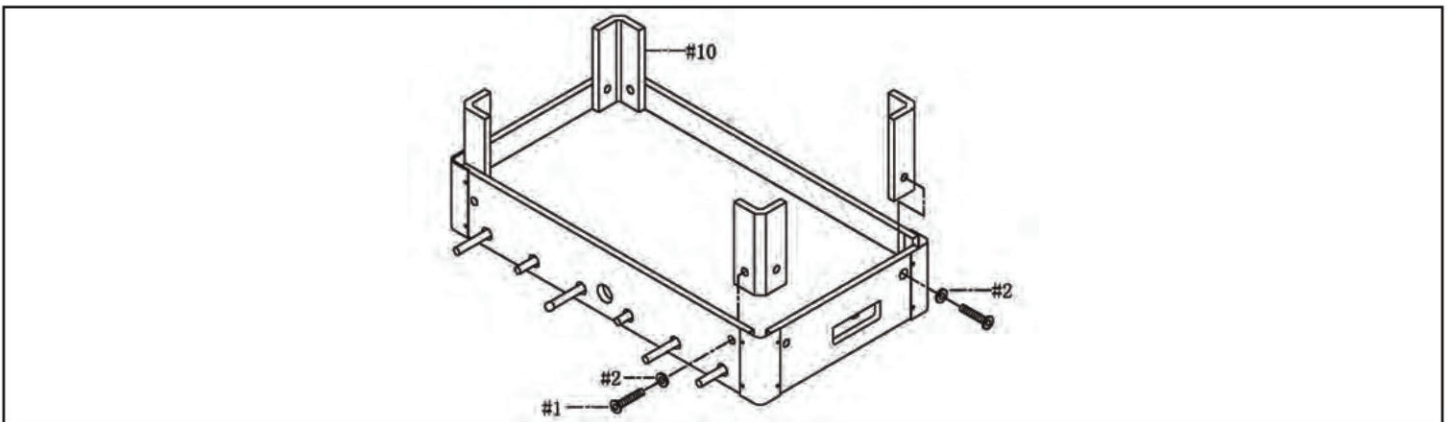

7. Attach HAND GRIP #12 to the marked end of each PLAYER ROD. Attach ROD END CAPS #15 to the opposite end of PLAYER RODS.

8. Attach one TWO-PIECE GOAL #5 to each end of the table with 1/2" SCREW #4.

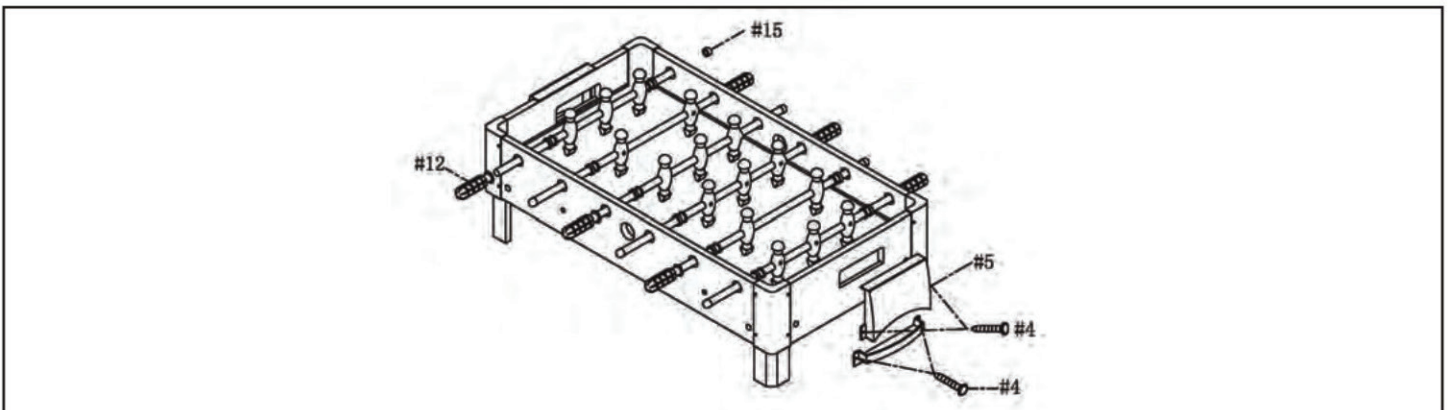

CONGRATULATIONS!

You have now assembled your Game Table.
Please note the Care and Use instructions below to ensure years of trouble free use of your game table.

CARE AND USE

1. This product is intended for **INDOOR** use only.
2. Do **NOT** sit, climb or lean on the table.
3. Do **NOT** drag the table when moving it as this will damage the legs.

180-DAY LIMITED WARRANTY

This product is warranted to the original purchaser to be free from defects in material or workmanship for a period of 180 days from the date of the original retail purchase.

This warranty does not cover defects or damage due to improper installation, alteration, accident or any other event beyond the control of the manufacturer. Defects or damage resulting from misuse, abuse or negligence will void this warranty. This warranty does not cover scratching or damage that may result from normal usage.

This product is not intended for institutional or commercial use; the manufacturer does not assume any liability for such use. Institutional or commercial use will void this warranty.

This warranty is nontransferable and is expressly limited to the repair or replacement of the defective product. During the warranty period, the manufacturer shall repair or replace defective parts at no cost to the purchaser. Shipping charges and insurance are not covered and are the responsibility of the purchaser. Labor charges and related expenses for removal, installation or replacement of the product or components are not covered under this warranty.

The manufacturer reserves the right to make substitutions to warranty claims if parts are unavailable or obsolete.

The manufacturer shall not be liable for loss of use of the product or other consequential or incidental costs, expenses or damages incurred by the consumer of any other use. The user assumes all risk of injury resulting from the use of this product.

This warranty is expressly in lieu of all other warranties, expressed or implied, including warranties of merchantability or fitness for use to the extent permitted by Federal or state law. Neither the manufacturer nor any of its representatives assumes any other liability in connection with this product.

All warranty claims must be made through the retailer where the product was originally purchased. A purchase receipt or other proof of date of purchase will be required to process all warranty claims. The model number and part numbers found within the assembly instructions will be required when submitting any parts requests or warranty claims.

For further warranty information or inquiries, please call 800-759-0977

PARTS LIST

NG1028T3

Product #	Description	Parts Identifier No.
NGP50963	HARDWARE	1-4 & 6
NGP50973	TWO-PIECE GOAL	5
NGP50983	SIDE PANEL	7
NGP50993	END PANEL	8
NGP51003	PLAYFIELD	9
NGP51013	LEG	10
NGP5102	SOCCER BALL	11
NGP51033	HAND GRIP	12
NGP51043	3 PLAYER ROD	13,14
NGP51053	2 PLAYER ROD	13,14
NGP51063	ROD END CAP	15
NGP51073	PLAYFIELD SUPPORT BRACE	16
NGP51083	CORNER	17
NGP51093	BLUE PLAYER	14
NGP51103	ORANGE PLAYER	13
NGP5162	FOAM BUMPER	18
NGP5184	PLASTIC ROD WASHER	19

Hardware Pack, NGP50963, includes:

BOLTS	1
FLAT WASHERS	2
1-1/2" SCREWS	3
1/2" SCREWS	4
HEX WRENCH	6







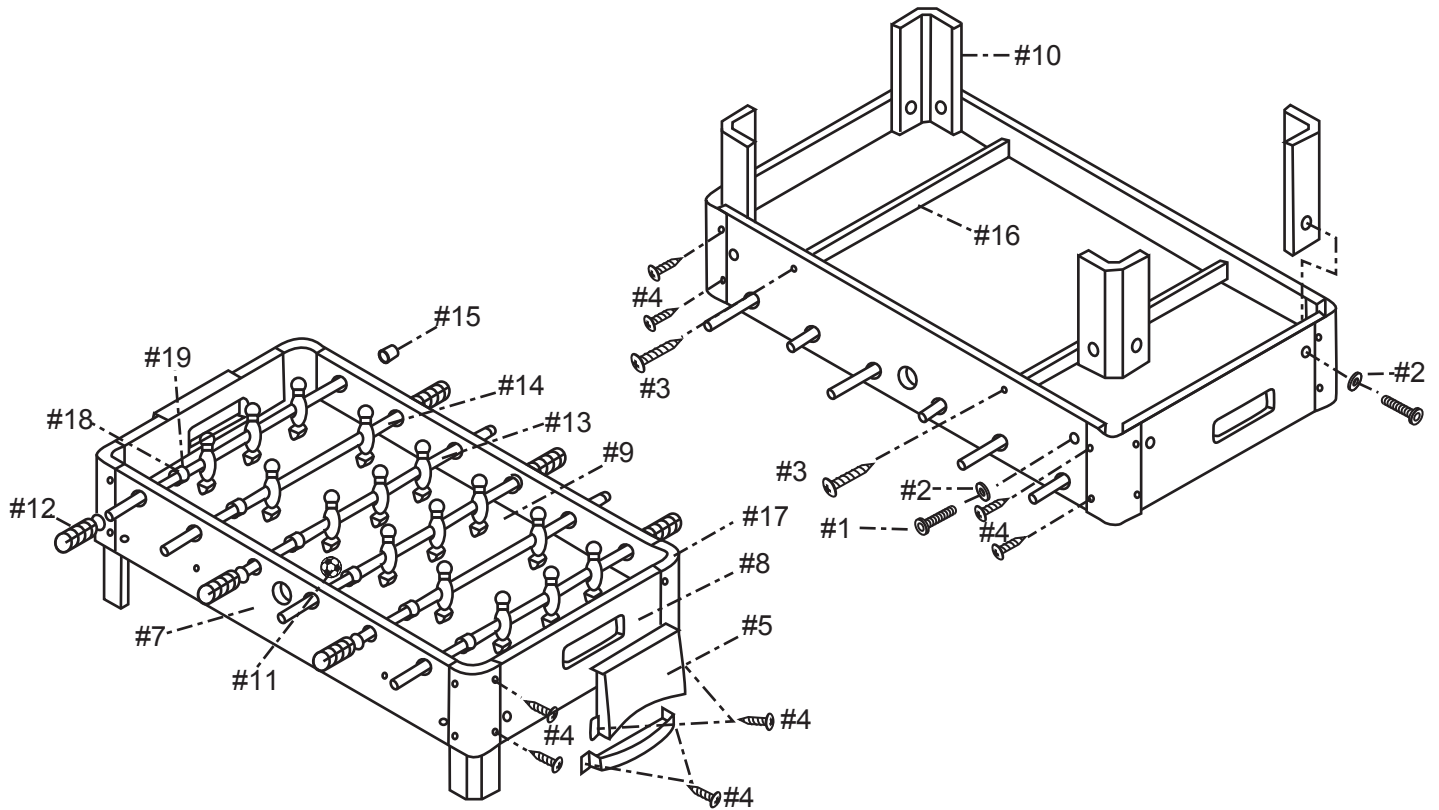

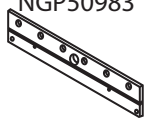

For replacement parts please call 800-759-0977

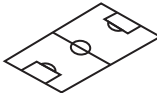
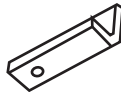
TABLE TOP FOOSBALL TABLE - NG1028T3

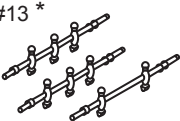
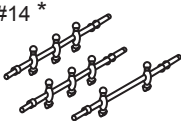
Parts List







PARTS

#5 NGP50973  TOW-PIECE GOAL 2 pcs	#7 NGP50983  SIDE PANEL 2 pcs	#8 NGP50993  END PANEL 2 pcs	#9 NGP51003  PLAYFIELD 1 pc	#10 NGP51013  LEG 4 pcs	#11 NGP5102  SOCCER BALL 2 pcs	#12 NGP51033  HAND GRID 6 pcs
#13 *  ORG. PLAYER ROD 3 pcs	#14 *  BLUE PLAYER ROD 3 pcs	#15 NGP51063  ROD END CAP 6 pcs	#16 NGP51073  PLAYFIELD SUPPORT 2 pcs	#17 NGP51083  CORNER 4 pcs	#18 NGP5162  FOAM BUMPER 12 pcs	#19 NGP5184  PLASTIC ROD WASHER 12 pcs

* 2 PLAYER ROD, NGP51053; 3 PLAYER ROD, NGP51043; ORANGE PLAYER, NGP51103; BLUE PLAYER, NGP51093

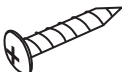
HARDWARE PACK - NGP50963

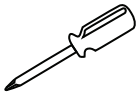
#1  BOLT 8 pcs	#2  FLAT WASHER 8 pcs	#3  1-1/2" SCREW 4 pcs	#4  1/2" SCREW 4 pcs	#6  HEX WRENCH 1 pc	ADDITIONAL EQUIPMENT REQUIRED:  PHILLIPS HEAD SCREWDRIVER
--	---	--	--	--	--