

54" CROSSFIRE SOCCER TABLE ASSEMBLY INSTRUCTIONS



NG1032F3











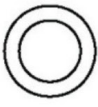



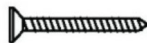
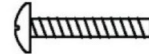

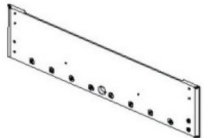
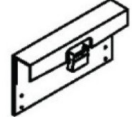

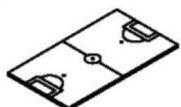









THANK YOU!

Thank you for purchasing this product.

We work around the clock and around the globe to ensure that our products maintain the highest possible quality. However, in the rare instance that your product is defective or missing parts, contact your retailer, or call 800-759-0977, to submit parts requests or warranty claims. Please read the warranty information at the back of these assembly instructions for further details.

**IMPORTANT! PLEASE READ THESE ASSEMBLY INSTRUCTIONS
IN ENTIRETY BEFORE ASSEMBLING YOUR PRODUCT.**

PARTS IDENTIFIER (NOT TO SCALE)

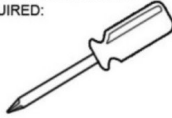
#1  1/4" FLAT WASHER 4 pcs	#2  1/4" LOCKNUT 4 pcs	#3  1-1/2" BOLT 24 pcs	#4  5/16" FLAT WASHER 24 pcs	#5  1/2" FLAT SCREW 12 pcs
#6  1-3/16" FLAT SCREW 4 pcs	#7  1-1/8" BOLT 26 pcs	#8  LOCKNUT 26 pcs	#9  SIDE PANEL 2 pcs	#10  END PANEL 2 pcs
#11  PLAYFIELD SUPPORT BRACE 2 pcs	#12  PLAYFIELD 1 pc	#13  LEG 4 pcs	#14  MANUAL SCORER 2 pcs	#15  ROD END CAP 8 pcs
#16  HAND GRIP 8 pcs	#17  RUBBER BUMPER 16 pcs	#18  PLASTIC ROD WASHER 16 pcs	#19  LEG LEVELER 4 pcs	#20  AWAY PLAYERS 13 pcs
#21  HOME PLAYERS 13 pcs	#22  5 PLAYER ROD 2 pcs	#23  2 PLAYER ROD 2 pcs	#24  3 PLAYER ROD 4 pcs	#25  2-PIECE BALL LAUNCHER 2 pcs
#26  1/2" SCREW 2 pcs	#27  SOCCER BALL 2 pcs	#28  HEX WRENCH 1 pc	#29  SUPPORT ROD 2 pcs	#30  DRINKING HOLDER 2 pcs
#31  5/12" SCREW 8 pcs	#32  1" FLAT SCREW 8 pcs	ADDITIONAL EQUIPMENT REQUIRED:  PHILLIPS HEAD SCREWDRIVER	Please see Parts List at end of manual for part number when ordering parts. For replacement parts please call 800-759-0977.	

ASSEMBLY TIPS

1. Find a clean, level surface to begin the assembly of your game table. The table will be partially assembled upside down and then turned over onto its legs. This is a heavy game and turning it over will require at least two strong adults.
2. Remove all of the contents from box and verify that you have all of the parts shown on the Parts Identifier before you begin assembly. **Note: Some parts may be pre-installed or pre-assembled.**
3. Some figures or drawings may not look exactly like your product. Please read and understand the text before beginning each assembly step.
4. **When installing parts that have more than one screw or bolt, hand tighten all screws or bolts in place before final tightening with screwdriver or hex wrench.**
5. Electric screwdrivers may be helpful during assembly; however, please set a **low torque** and use extreme caution because screws may be stripped or overtightened, resulting in damaged parts, if the electric screwdriver's torque is set too high.

WARNINGS!

READ AND FOLLOW ALL ASSEMBLY, OPERATION AND SAFETY INSTRUCTIONS CAREFULLY.

**CHOKER HAZARD - THIS TABLE CONTAINS SMALL BALLS AND PARTS
NOT SUITABLE FOR CHILDREN UNDER 3 YEARS OF AGE.**

ASSEMBLY INSTRUCTIONS

1. Place PLAYFIELD #12 with field markings facing down onto the supports on SIDE PANELS #9.
Note: The table is assembled upside down.

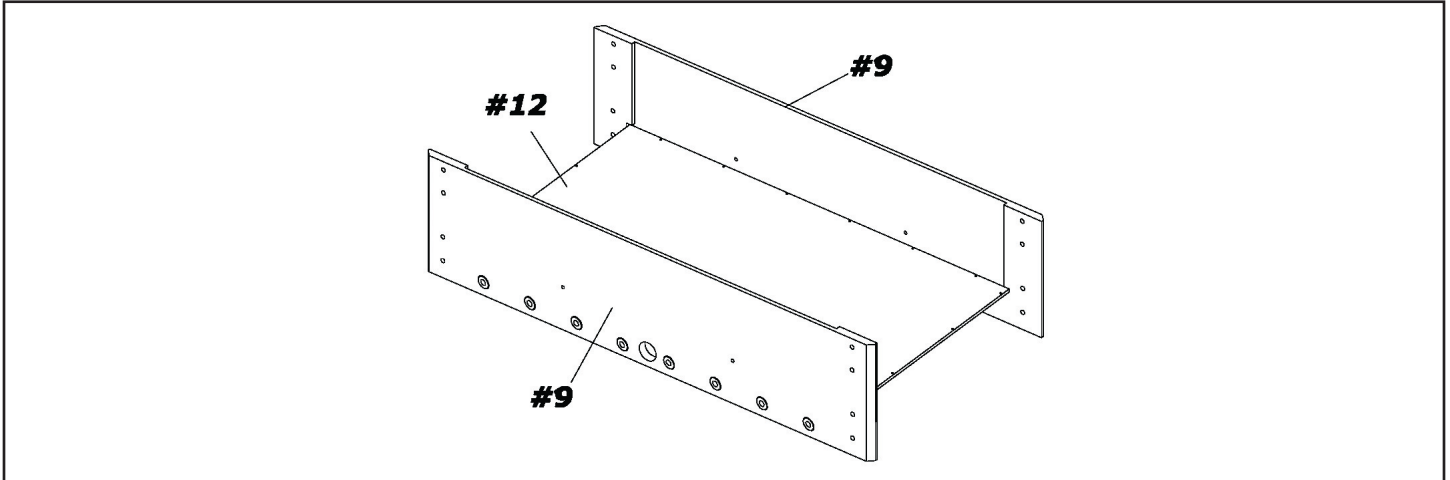

2. Attach one END PANEL #10 to each end of the table with 1-1/2" BOLT #3 and 5/16" FLAT WASHER #4.
Note: Playfield fits into groove on both End Panels.

3. Secure PLAYFIELD to table with 1" FLAT SCREW #5 on two side edges using pre-drilled hole locations.

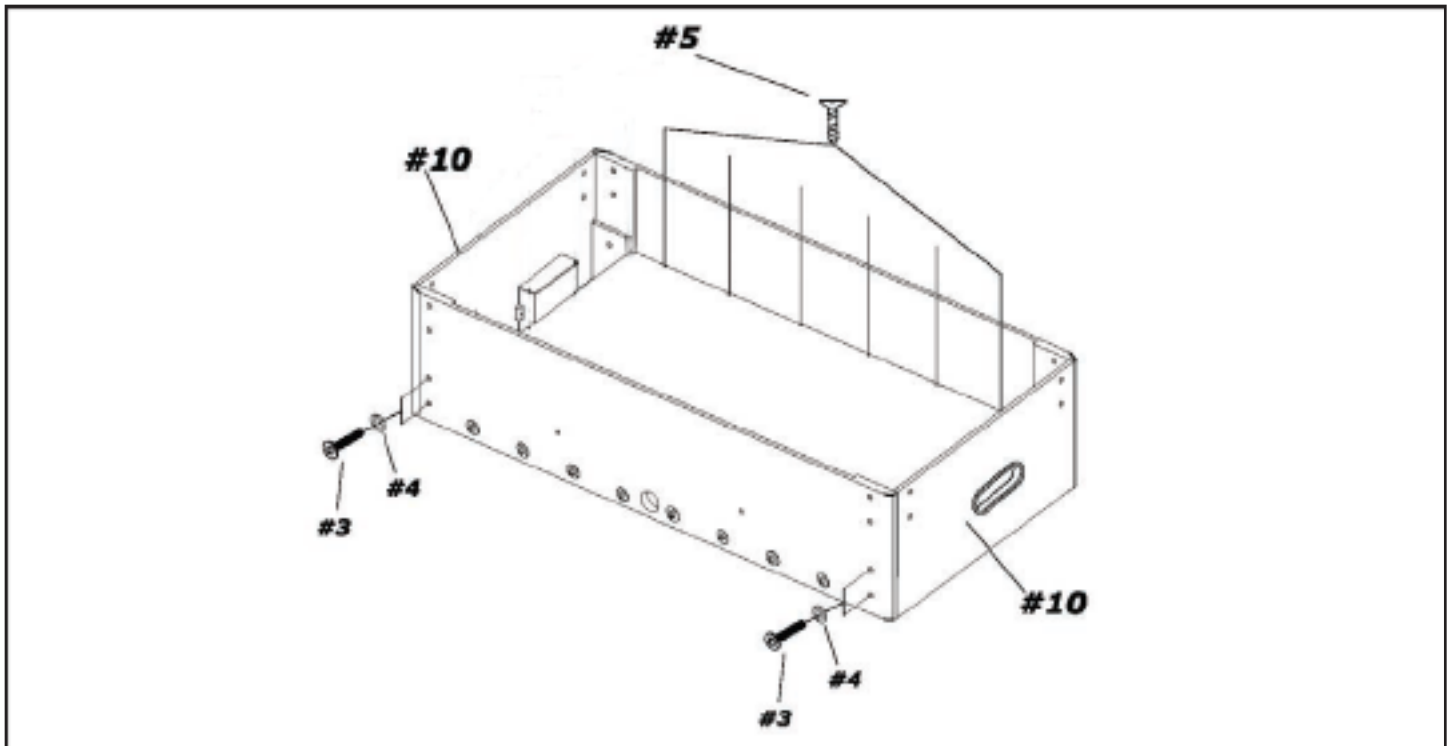

ASSEMBLY INSTRUCTIONS (CONT.)

4. Position each PLAYFIELD SUPPORT BRACE #11 between the SIDE PANELS as shown below. Thread one SUPPORT ROD #29 through SIDE PANEL and each PLAYFIELD SUPPORT BRACE. Secure SUPPORT RODS to both SIDE PANELS with 1/4" LOCKNUTS #2 and 1/4" FLAT WASHERS #1.

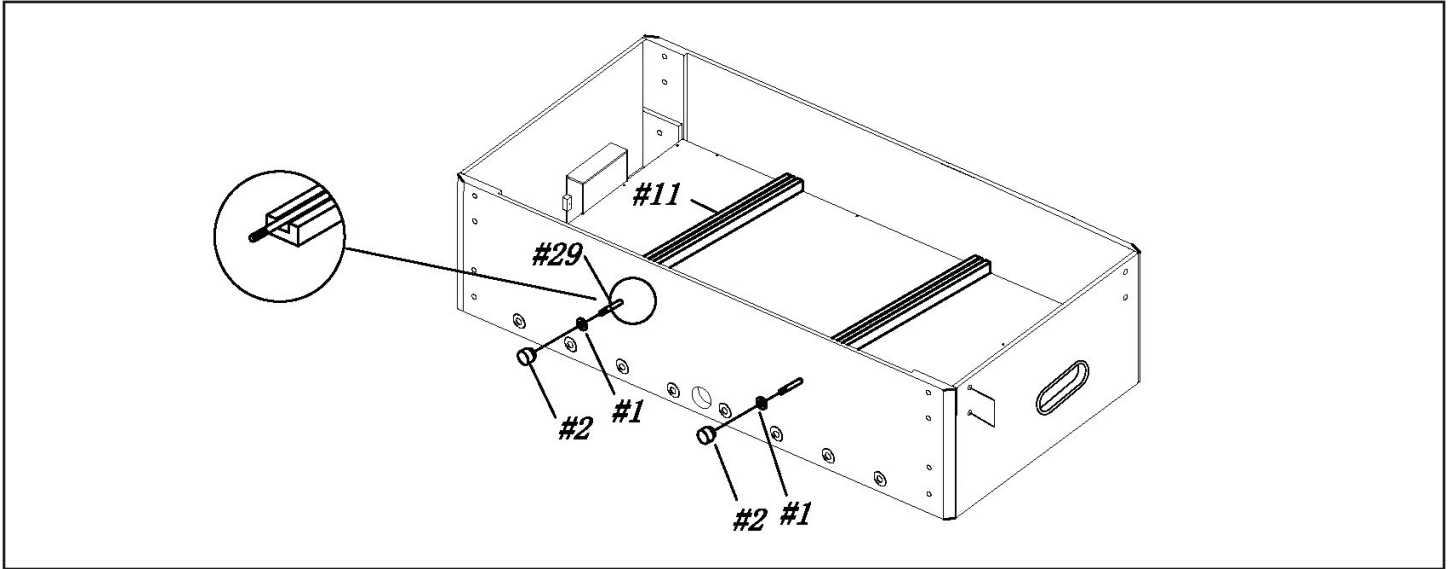

5. Attach one LEG #13 to each corner of the table with 1-1/2" BOLT #3 and 5/16" FLAT WASHER #4.

6. Thread one LEG LEVELER #19 onto each LEG. Carefully turn table over.

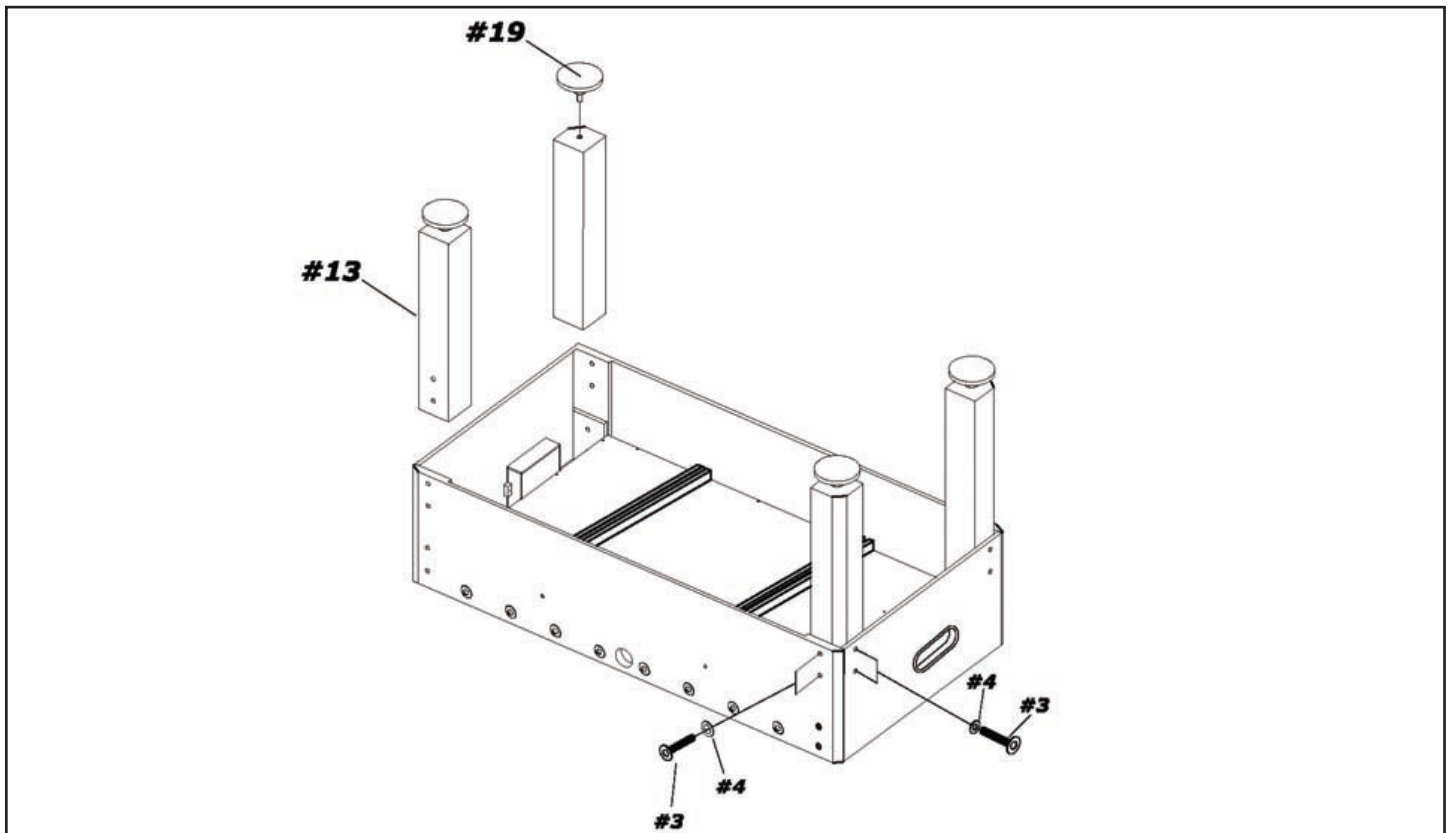

ASSEMBLY INSTRUCTIONS (CONT.)

7. Before assembling PLAYER RODS, refer to the diagrams below for correct rod orientation and player placement. *Note: You may choose either color for home or away teams.*

8. Begin PLAYER ROD assembly by partially inserting PLAYER ROD into appropriate hole in the SIDE PANEL. *Note: the HAND GRIP will be attached to the marked end of the PLAYER ROD.* Slide one RUBBER BUMPER #17 and PLASTIC ROD WASHER #18 onto the partially inserted PLAYER ROD. Slide the appropriate quantity and color player onto the PLAYER ROD. Finish PLAYER ROD assembly with PLASTIC ROD WASHER #18 and RUBBER BUMPER #17. Insert PLAYER ROD into opposite SIDE PANEL. Fasten PLAYERS to PLAYER RODS with 1-1/8" BOLT #7 and LOCKNUT #8.

9. Repeat assembly with remaining PLAYER RODS. *Note: Each team should face opposite goal.*

10. Attach HAND GRIP #16 to appropriate end of PLAYER ROD, and fasten with 1" FLAT SCREW #32. Attach ROD END CAP #15 to the opposite end.

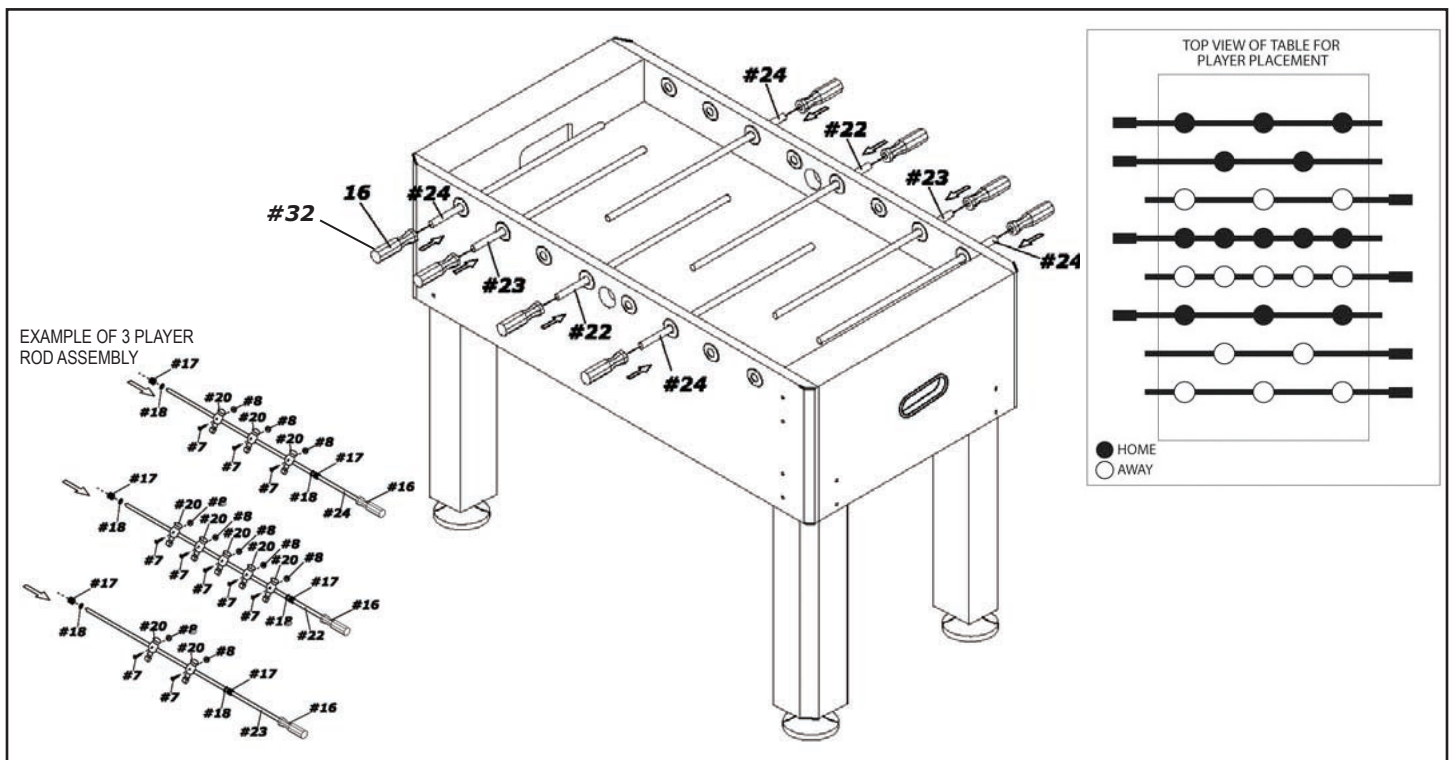

ASSEMBLY INSTRUCTIONS (CONT.)

11. Attach one **MANUAL SCORER #14** to the top of each **END PANEL** with **1-3/16" FLAT SCREW #6**.

12. Attach one **TWO-PIECE BALL LAUNCHER #25** to each side of the table by inserting the cup into the hole on the outside edge of the **SIDE PANEL** and the launcher into the hole on the inside edge of the **SIDE PANEL**. Fasten to table with **1/2" FLAT SCREW #26**.

13. Attach one **DRINK HOLDER #30** to each side of the table and fasten to the table with **5/12" FLAT SCREW #31**

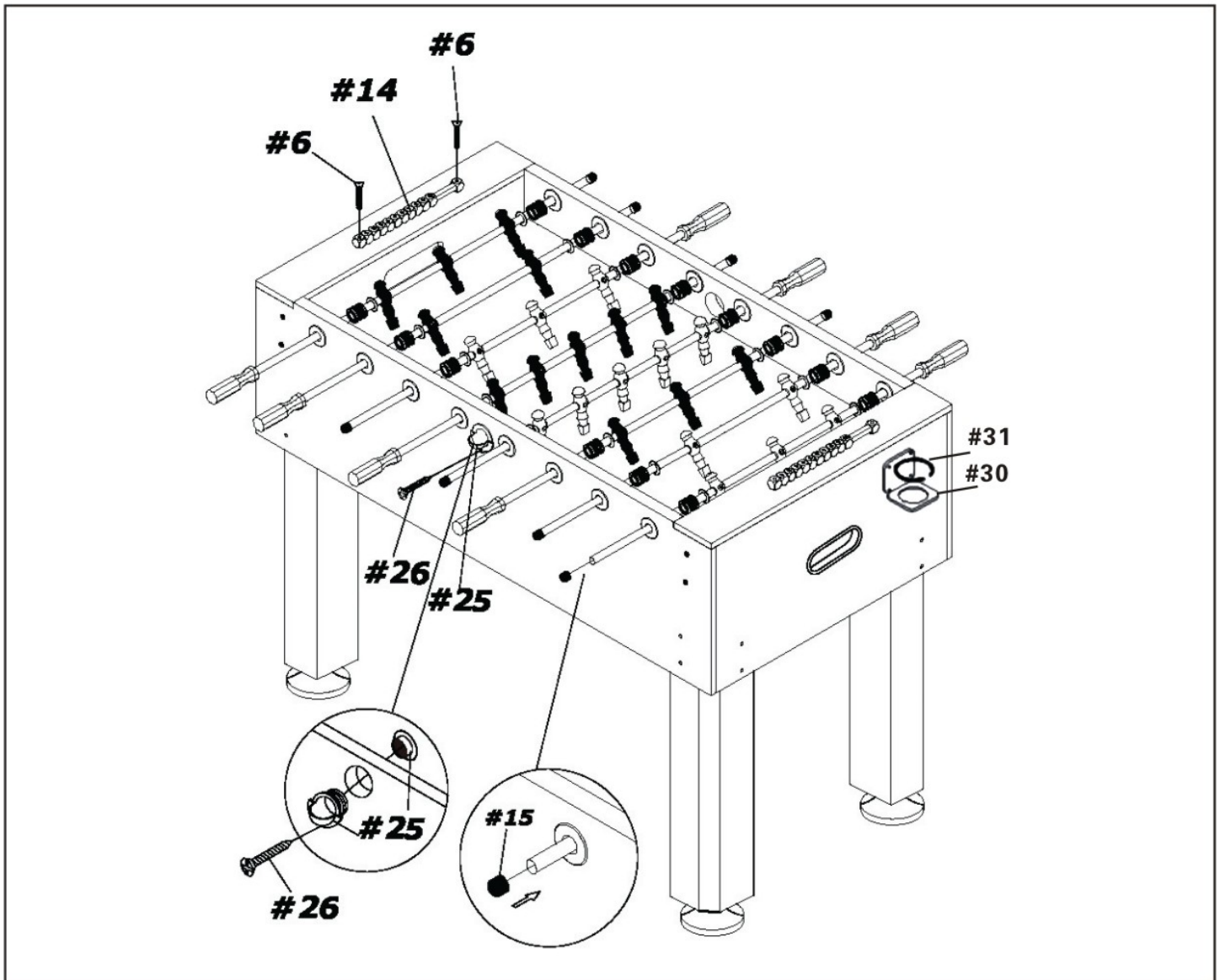

CONGRATULATIONS!

You have now assembled your Game Table.
Please note the Care and Use instructions below to ensure years of trouble free use of your game table.

CARE AND USE

1. This product is intended for **INDOOR** use only.
2. Do **NOT** sit, climb or lean on the table.
3. Do **NOT** drag the table when moving it as this will damage the legs.

180-DAY LIMITED WARRANTY

This product is warranted to the original purchaser to be free from defects in material or workmanship for a period of 180 days from the date of the original retail purchase.

This warranty does not cover defects or damage due to improper installation, alteration, accident or any other event beyond the control of the manufacturer. Defects or damage resulting from misuse, abuse or negligence will void this warranty. This warranty does not cover scratching or damage that may result from normal usage.

This product is not intended for institutional or commercial use; the manufacturer does not assume any liability for such use. Institutional or commercial use will void this warranty.

This warranty is nontransferable and is expressly limited to the repair or replacement of the defective product. During the warranty period, the manufacturer shall repair or replace defective parts at no cost to the purchaser. Shipping charges and insurance are not covered and are the responsibility of the purchaser. Labor charges and related expenses for removal, installation or replacement of the product or components are not covered under this warranty.

The manufacturer reserves the right to make substitutions to warranty claims if parts are unavailable or obsolete.

The manufacturer shall not be liable for loss of use of the product or other consequential or incidental costs, expenses or damages incurred by the consumer of any other use. The user assumes all risk of injury resulting from the use of this product.

This warranty is expressly in lieu of all other warranties, expressed or implied, including warranties of merchantability or fitness for use to the extent permitted by Federal or state law. Neither the manufacturer nor any of its representatives assumes any other liability in connection with this product.

All warranty claims must be made through the retailer where the product was originally purchased. A purchase receipt or other proof of date of purchase will be required to process all warranty claims. The model number and part numbers found within the assembly instructions will be required when submitting any parts requests or warranty claims.







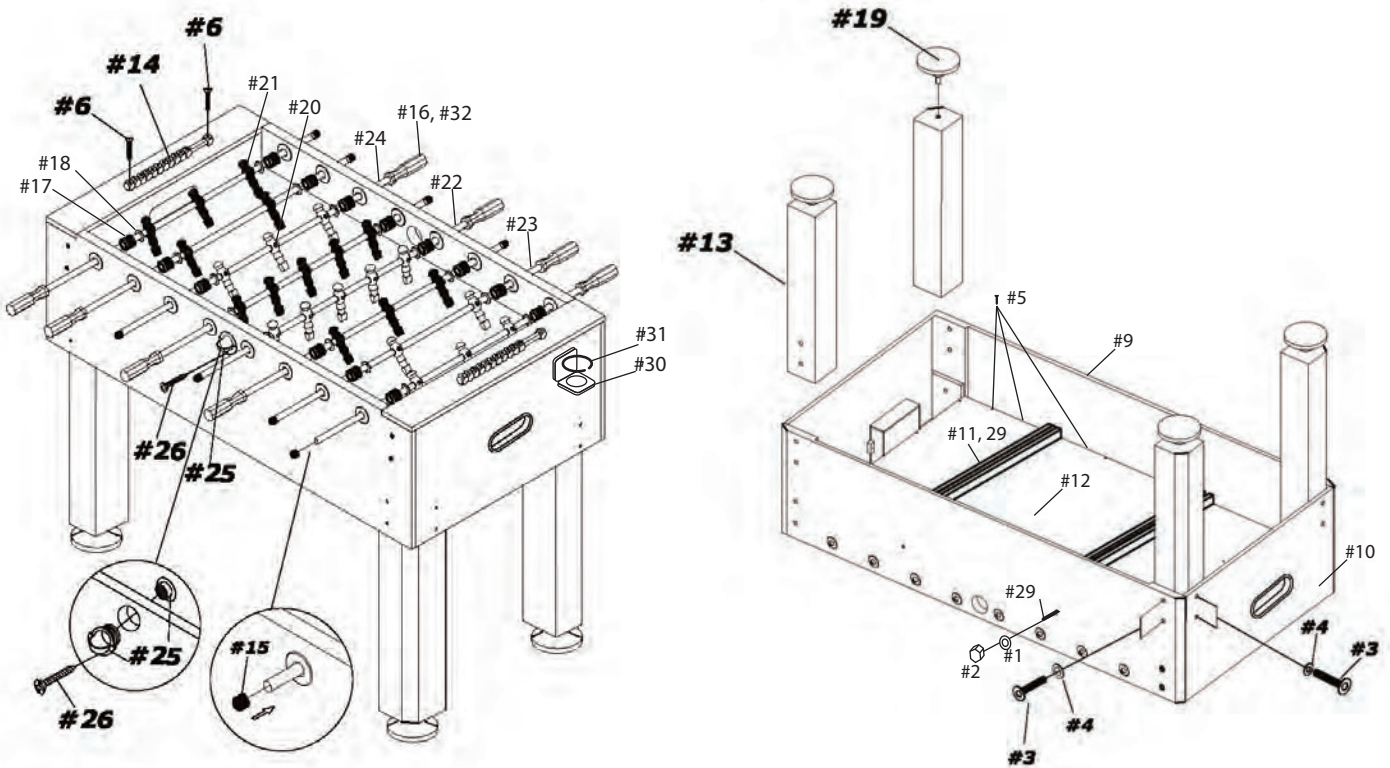



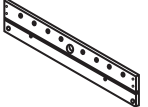
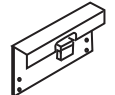



For further warranty information or inquiries, please call 800-759-0977

CROSSFIRE SOCCER TABLE- NG1032F3













Parts List



PARTS

#9 NGP51643  SIDE PANEL	#10 NGP51653  END PANEL	#11 NGP51663  PLAYFIELD SUPPORT BRACE	#12 NGP51673  PLAYFIELD	#13 NGP51683  LEG	#14 NGP51763 NGP51773  MANUAL SCORER	#15 NGP51693  ROD END CAP
#16 NGP51703  HAND GRID	#17 NGP51713  RUBBER BUMPER	#18 NGP51723  PLASTIC ROD WASHER	#19 NGP51733  LEG LEVELER	#20 NGP51783  AWAY PLAYER - GREEN	#21 NGP51793  HOME PLAYER - BLUE	#22 NGP51803  5 PLAYER ROD
#23 NGP51813  2 PLAYER ROD	#24 NGP51823  3 PLAYER ROD	#25 NGP51743  2-PIECE BALL LAUNCHER	#27 NGP5175  SOCCER BALL	#29 NGP51833  SUPPORT ROD	#30 NGP51843  DRINKING HOLDER	

HARDWARE PACK - NGP51633

<p>#1</p>  <p>1/4" FLAT WASHER 4 pcs</p>	<p>#2</p>  <p>1/4" LOCKNUT 4 pcs</p>	<p>#3</p>  <p>1-1/2" BOLT 24 pcs</p>	<p>#4</p>  <p>5/16" FLAT WASHER 24 pcs</p>	<p>#5</p>  <p>1/2" FLAT SCREW 12 pcs</p>	<p>#6</p>  <p>1-3/16" FLAT SCREW 4 pcs</p>	<p>#7</p>  <p>1-1/8" BOLT 26 pcs</p>
<p>#8</p>  <p>LOCKNUT 26 pcs</p>	<p>#26</p>  <p>1/2" FLAT SCREW 2 pcs</p>	<p>#28</p>  <p>HEX WRENCH 1 pc</p>	<p>#31</p>  <p>5/12" FLAT SCREW 8 pcs</p>	<p>#32</p>  <p>1" FLAT SCREW 8 pcs</p>	<p>ADDITIONAL EQUIPMENT REQUIRED:</p>  <p>PHILLIPS HEAD SCREWDRIVER</p>	