

# 9' & 12' CHALLENGER SHUFFLEBOARD TABLE ASSEMBLY INSTRUCTIONS



NG1205 / NG1210 / NG1212 / NG1214









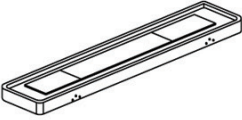
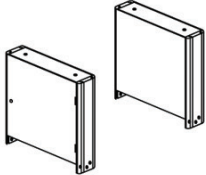
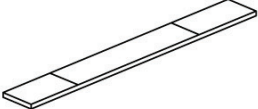

**THANK YOU!**

Thank you for purchasing this product.

We work around the clock and around the globe to ensure that our products maintain the highest possible quality. However, in the rare instance that your product is defective or missing parts, contact your retailer, or call 800-759-0977, to submit parts requests or warranty claims. Please read the warranty information at the back of these assembly instructions for further details.

**IMPORTANT! PLEASE READ THESE ASSEMBLY INSTRUCTIONS  
IN ENTIRETY BEFORE ASSEMBLING YOUR PRODUCT.**

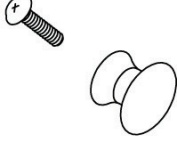
# PARTS IDENTIFIER (NOT TO SCALE)

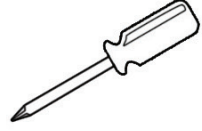
<p>#1</p>  <p><b>TABLE BODY</b> 1 pc</p>	<p>#2</p>  <p><b>LEG</b> 2 pcs</p>	<p>#3</p>  <p><b>PLAYFIELD (PRE-ASSEMBLED)</b> 1 pc</p>	<p>#4</p>  <p><b>LEG LEVELER</b> 4 pcs</p>	<p>#5</p>  <p><b>2-1/4" BOLT</b> 12 pcs</p>
<p>#6</p>  <p><b>FLAT WASHER</b> 12 pcs</p>	<p>#7</p>  <p><b>RED PUCK/BLUE PUCK</b> 4 pcs ea</p>	<p>#8</p>  <p><b>MANUAL SCORER</b> 2 pcs</p>	<p>#9</p>  <p><b>1-1/2" SCREW</b> 4 pcs</p>	<p>#10</p>  <p><b>SCREW CAP</b> 4 pcs</p>
<p>#11</p>  <p><b>WRENCH</b> 1 pc</p>	<p>#12</p>  <p><b>DOOR HANDLE</b> 1 SET</p>	<p>#13</p>  <p><b>SHUFFLEBOARD WAX</b> 1 pc</p>	<p>ADDITIONAL EQUIPMENT REQUIRED:</p>  <p><b>PHILLIPS HEAD SCREWDRIVER</b></p>	

Please see Parts List at end of manual for part number when ordering parts. For replacement parts please call 800-759-0977.

## ASSEMBLY TIPS

1. Find a clean, level surface to begin the assembly of your game table. The table will be partially assembled upside down and then turned over onto its legs. **This is a heavy game and turning it over will require at least two strong adults. Important: when laying the game table face down, be sure to have proper padding to prevent any damage to surface.**
2. Remove all of the contents from box and verify that you have all of the parts shown on the Parts Identifier before you begin assembly. **Note: Some parts may be pre-installed or pre-assembled.**
3. Some figures or drawings may not look exactly like your product. Please read and understand the text before beginning each assembly step.
4. **When installing parts that have more than one screw or bolt, hand tighten all screws or bolts in place before finishing tightening with screwdriver or hex wrench.**
5. Electric screwdrivers may be helpful during assembly; however, please set a low torque and use extreme caution because screws may be stripped or overtightened if the electric screwdriver's torque is set too high.

### **WARNINGS!**

READ AND FOLLOW ALL ASSEMBLY, OPERATION AND SAFETY INSTRUCTIONS CAREFULLY.

CHOKER HAZARD - THIS TABLE CONTAINS SMALL PARTS - NOT SUITABLE FOR CHILDREN UNDER 4 YEARS OF AGE.



# ASSEMBLY INSTRUCTIONS

1. Attach LEGS #2 to the underside of the TABLE BODY #1 as shown with 2-1/4" BOLT #5 and FLAT WASHER #6. *Note: The door opening must face outwards.*
2. Attach two LEG LEVELERS #4 to each LEG as shown.

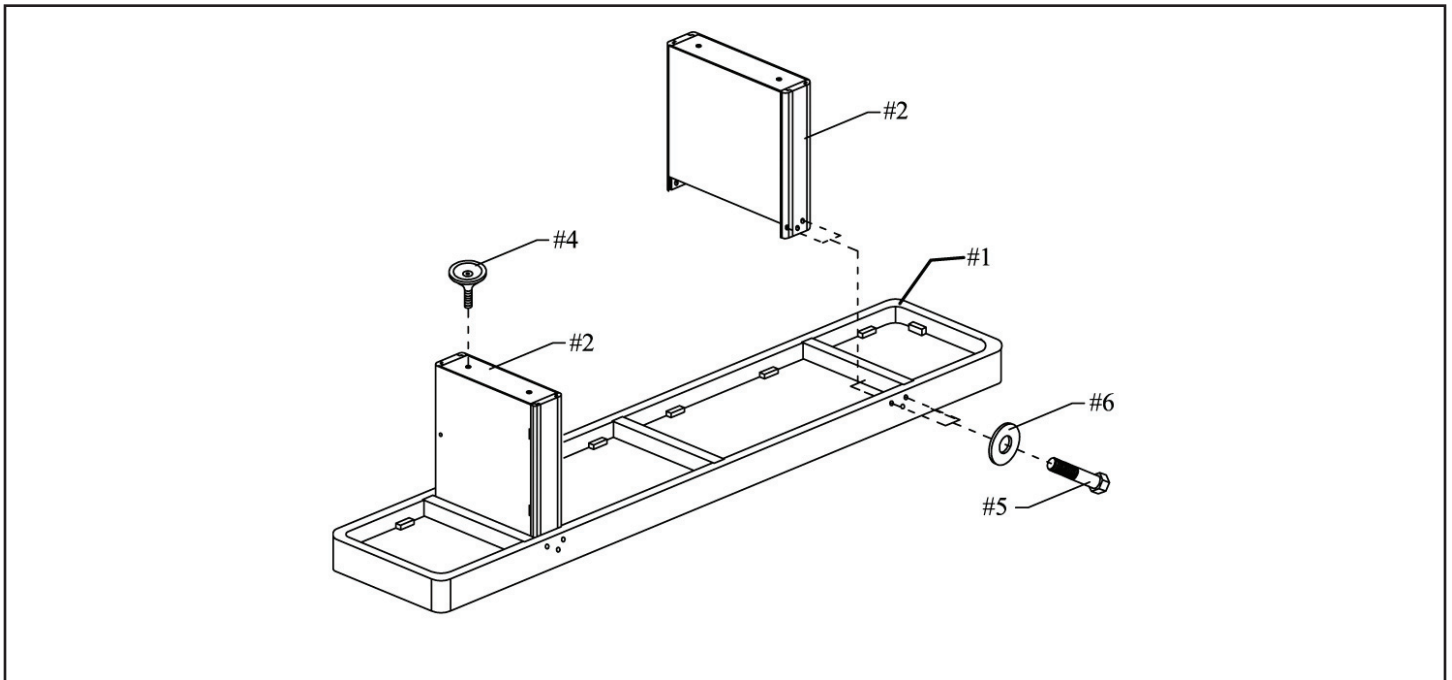

3. Carefully turn table over. Attach MANUAL SCORERS #8 to TABLE BODY as shown with 1-1/2" SCREW #9. Use the playing field "3" line as a guide to align the end of the MANUAL SCORERS, as shown, for placement. Cover each SCREW with one SCREW CAP #10.
4. Attach DOOR HANDLE #12 to door opening on LEG.

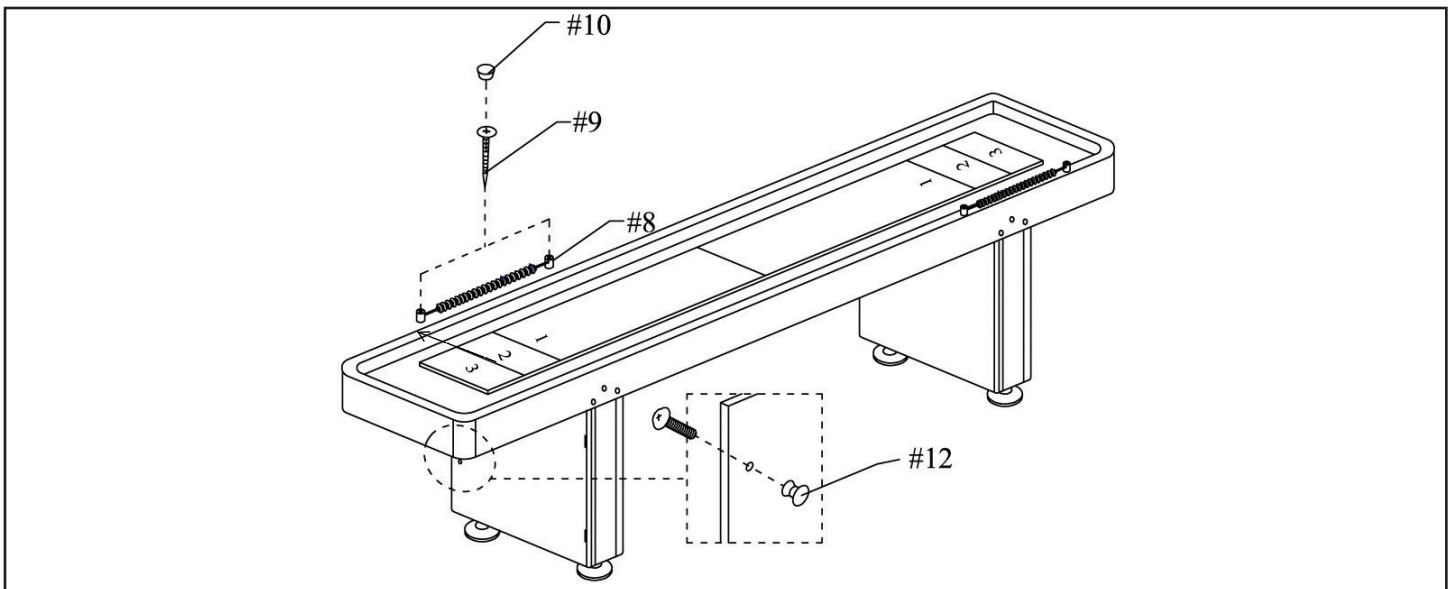

# CONGRATULATIONS!

You have now assembled your Game Table. Please note the Care and Use instructions below to ensure years of trouble free use of your game table.

## CARE AND USE

1. This product is intended for INDOOR use only.
2. Do NOT sit, climb or lean on the table.
3. Do NOT drag the table when moving it as this will damage the legs.
4. This Shuffleboard is equipped with Climatic Adjusters underneath the table to level the playfield. Because of humid weather or dry conditions, it is occasionally necessary to make adjustments in order to keep the playfield true. **Make sure your table is level in both directions using Leg Levelers before making any adjustments using the Climatic Adjusters.**

If necessary, begin the adjustment process by placing a straight edge across the playfield directly above the first Climatic Adjuster at either end of the table. This will determine if the playfield is concave or convex. The shuffleboard surface should be slightly concave to prevent the pucks from falling off the sides of the board.

Each Climatic Adjuster consists of three anchor bolts attached to the underside of the playfield through a metal bar. Adjustments will be made to the center bolt only. The outer two bolts are used to hold the metal bar in place.

To correct a convex playfield, loosen the nut above the metal bar. Slowly tighten the nut below the metal bar up against the bar in order to pull the center of the playfield down.

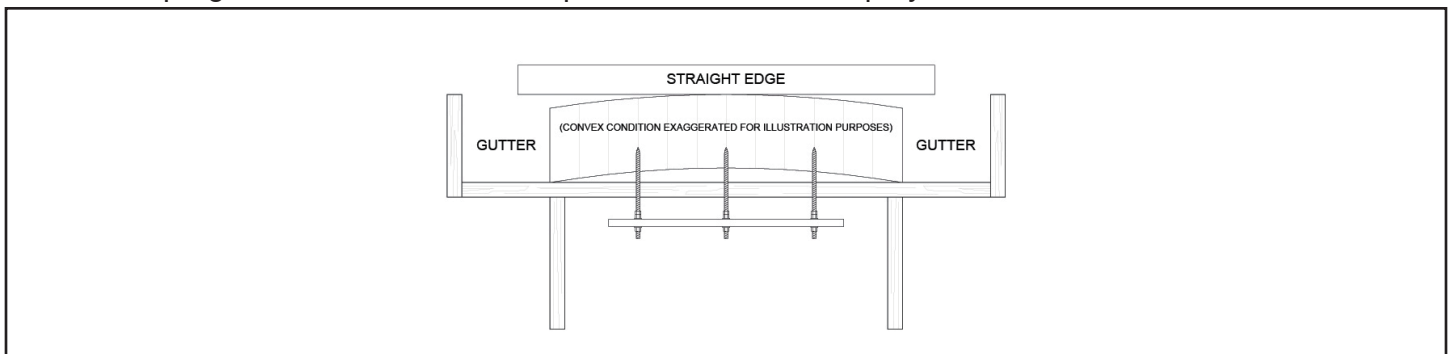

To correct a concave playfield, loosen the nut below the metal bar. Slowly tighten the nut above the metal bar down against the bar in order to push the center of the playfield up.

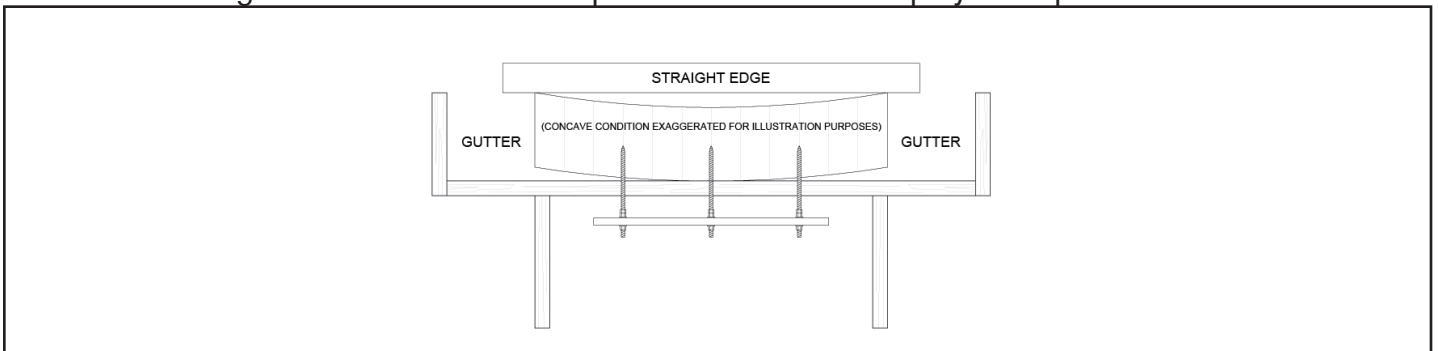

**Important: nuts should be tightened slowly with 1/4 to 3/4 turns at a time. It may take a few days for the shuffleboard to completely react. DO NOT over tighten, as this can cause permanent damage to the Climatic Adjusters and your table.**

Once the desired adjustment has been made, continue to the next Climatic Adjuster and repeat the process.

Please note that the shuffleboard will react to the adjustments for several days. Check the playfield again after a few days to determine if further adjustments are needed.

# 180-DAY LIMITED WARRANTY

This product is warranted to the original purchaser to be free from defects in material or workmanship for a period of 180 days from the date of the original retail purchase.

This warranty does not cover defects or damage due to improper installation, alteration, accident or any other event beyond the control of the manufacturer. Defects or damage resulting from misuse, abuse or negligence will void this warranty. This warranty does not cover scratching or damage that may result from normal usage.

This product is not intended for institutional or commercial use; the manufacturer does not assume any liability for such use. Institutional or commercial use will void this warranty.

This warranty is nontransferable and is expressly limited to the repair or replacement of the defective product. During the warranty period, the manufacturer shall repair or replace defective parts at no cost to the purchaser. Shipping charges and insurance are not covered and are the responsibility of the purchaser. Labor charges and related expenses for removal, installation or replacement of the product or components are not covered under this warranty.

The manufacturer reserves the right to make substitutions to warranty claims if parts are unavailable or obsolete.

The manufacturer shall not be liable for loss of use of the product or other consequential or incidental costs, expenses or damages incurred by the consumer of any other use. The user assumes all risk of injury resulting from the use of this product.

This warranty is expressly in lieu of all other warranties, expressed or implied, including warranties of merchantability or fitness for use to the extent permitted by Federal or state law. Neither the manufacturer nor any of its representatives assumes any other liability in connection with this product.

**All warranty claims must be made through the retailer where the product was originally purchased. A purchase receipt or other proof of date of purchase will be required to process all warranty claims. The model number and part numbers found within the assembly instructions will be required when submitting any parts requests or warranty claims.**





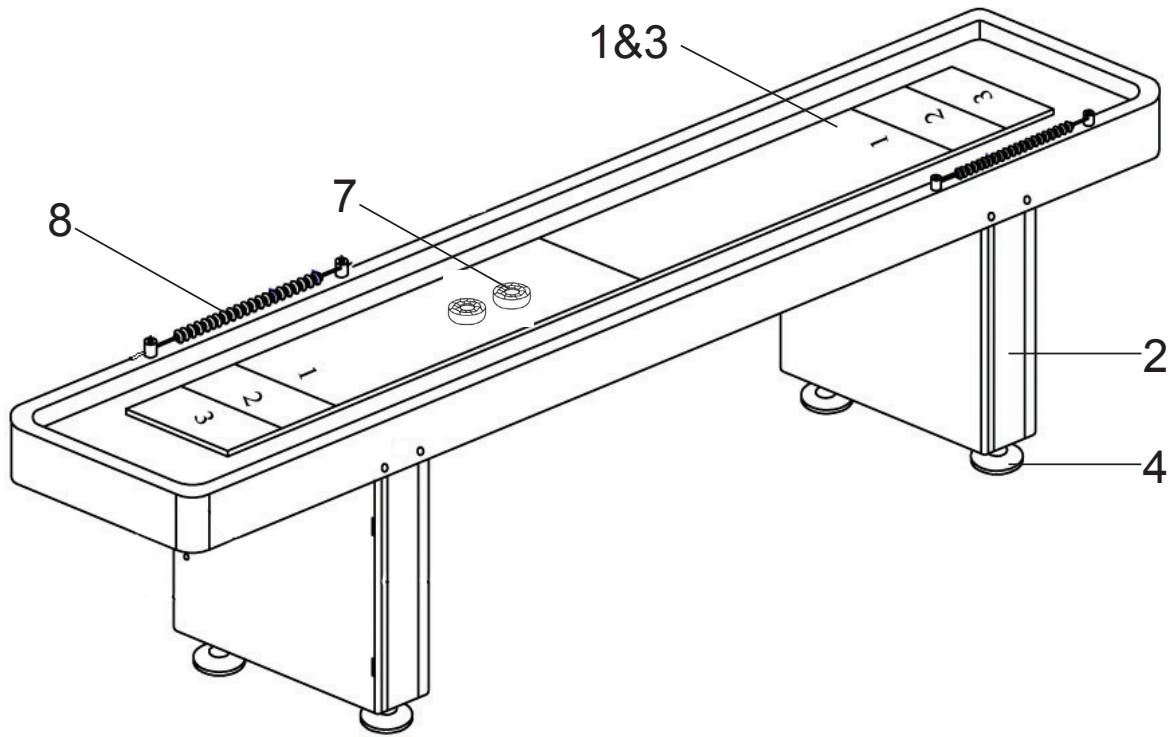

**For further warranty information or inquiries, please call 800-759-0977**

# 9 FOOT WALNUT SHUFFLEBOARD TABLE - NG1205

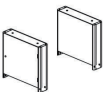

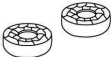

## Parts List



### PARTS

<b>#1&amp;3</b> NGP2611  TABLE BODY AND PLAYFIELD 9'	<b>#2</b> NGP2612  LEG PIECE	<b>#4</b> NGP2614  LEG LEVELER	<b>#7</b> NGP2606  RED PUCK	<b>#7</b> NGP2607  BLUE PUCK	<b>#8</b> NGP2615  MANUAL SCORER	<b>#10&amp;12</b> NGP2616  SCREW CAP & DOOR HANDLE
---	---	---	--	--	---	---

### HARDWARE PACK - NGP2604



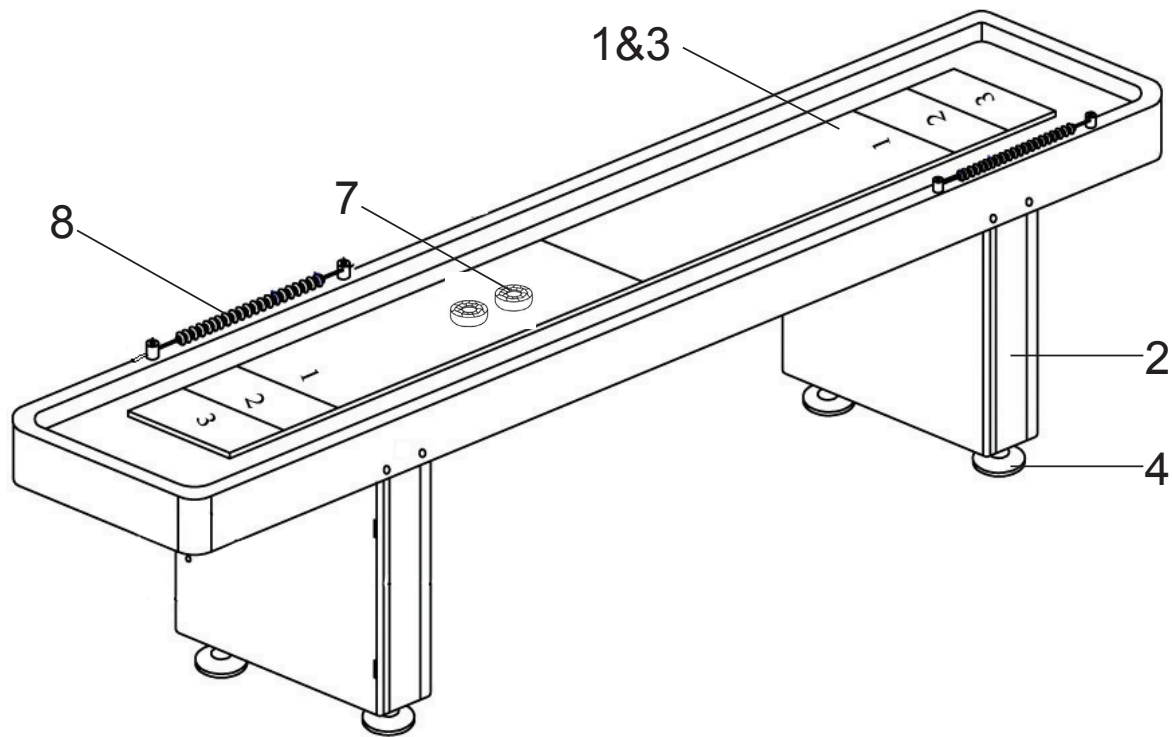

<b>#5</b>  2-1/4" BOLT	<b>#6</b>  FLAT WASHER	<b>#9</b>  1-1/2" SCREW	<b>#11</b>  WRENCH	ADDITIONAL EQUIPMENT REQUIRED:  PHILLIPS HEAD SCREWDRIVER
---	---	--	---	---

# 9 FOOT DK. CHERRY SHUFFLEBOARD TABLE - NG1210



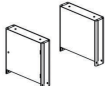

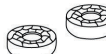
## Parts List

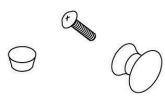

### PARTS

<p><b>#1&amp;3</b> NGP2601</p>  <p>TABLE BODY AND PLAYFIELD 9'</p>	<p><b>#2</b> NGP2602</p>  <p>LEG PIECE</p>	<p><b>#4</b> NGP2603</p>  <p>LEG LEVELER</p>	<p><b>#7</b> NGP2606</p>  <p>RED PUCK</p>	<p><b>#7</b> NGP2607</p>  <p>BLUE PUCK</p>	<p><b>#8</b> NGP2608</p>  <p>MANUAL SCORER</p>	<p><b>#10&amp;12</b> NGP2610</p>  <p>SCREW CAP &amp; DOOR HANDLE</p>
---	---	---	--	--	---	---

### HARDWARE PACK - NGP2604

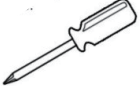

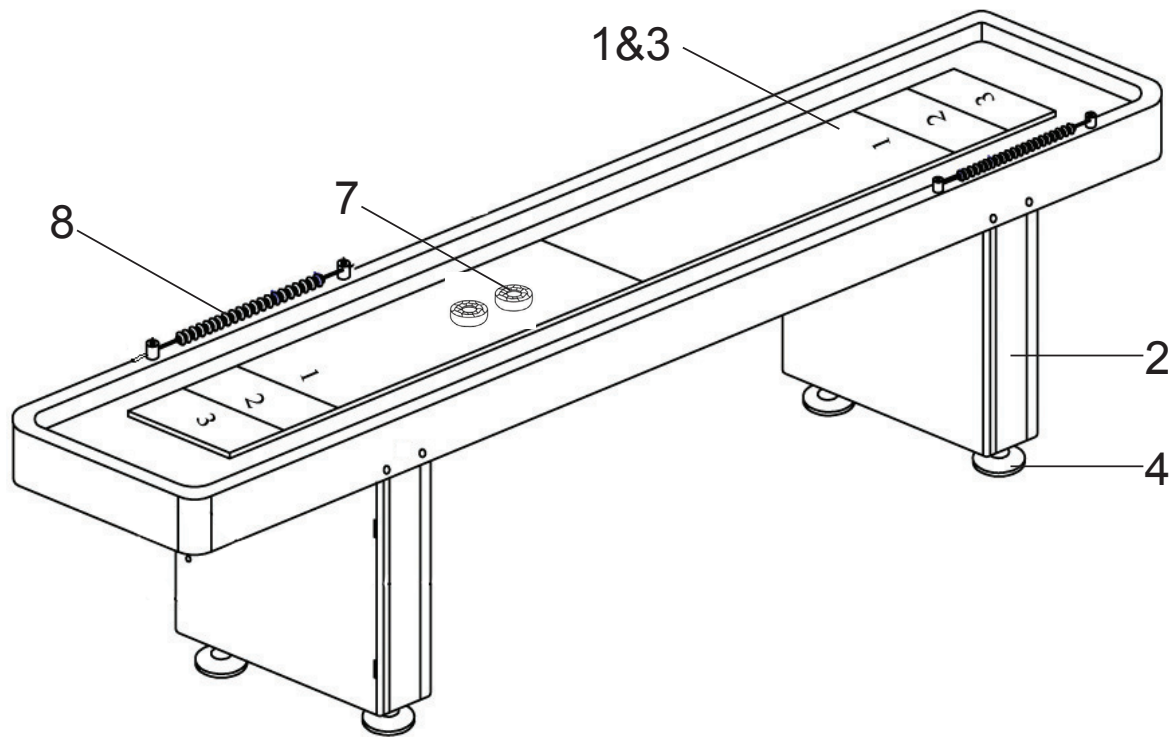

<p><b>#5</b></p>  <p>2-1/4" BOLT</p>	<p><b>#6</b></p>  <p>FLAT WASHER</p>	<p><b>#9</b></p>  <p>1-1/2" SCREW</p>	<p><b>#11</b></p>  <p>WRENCH</p>	<p>ADDITIONAL EQUIPMENT REQUIRED:</p>  <p>PHILLIPS HEAD SCREWDRIVER</p>
---	---	--	---	---

# 12 FOOT WALNUT SHUFFLEBOARD TABLE - NG1212

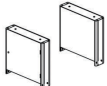

## Parts List

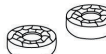

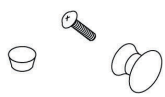
### PARTS

<p><b>#1&amp;3</b> NGP2613</p>  <p>TABLE BODY AND PLAYFIELD 12'</p>	<p><b>#2</b> NGP2612</p>  <p>LEG PIECE</p>	<p><b>#4</b> NGP2614</p>  <p>LEG LEVELER</p>	<p><b>#7</b> NGP2606</p>  <p>RED PUCK</p>	<p><b>#7</b> NGP2607</p>  <p>BLUE PUCK</p>	<p><b>#8</b> NGP2615</p>  <p>MANUAL SCORER</p>	<p><b>#10&amp;12</b> NGP2616</p>  <p>SCREW CAP &amp; DOOR HANDLE</p>
--	---	---	--	--	---	---

### HARDWARE PACK - NGP2604

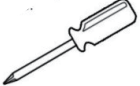
<p><b>#5</b></p>  <p>2-1/4" BOLT</p>	<p><b>#6</b></p>  <p>FLAT WASHER</p>	<p><b>#9</b></p>  <p>1-1/2" SCREW</p>	<p><b>#11</b></p>  <p>WRENCH</p>	<p>ADDITIONAL EQUIPMENT REQUIRED:</p>  <p>PHILLIPS HEAD SCREWDRIVER</p>
---	---	--	---	---





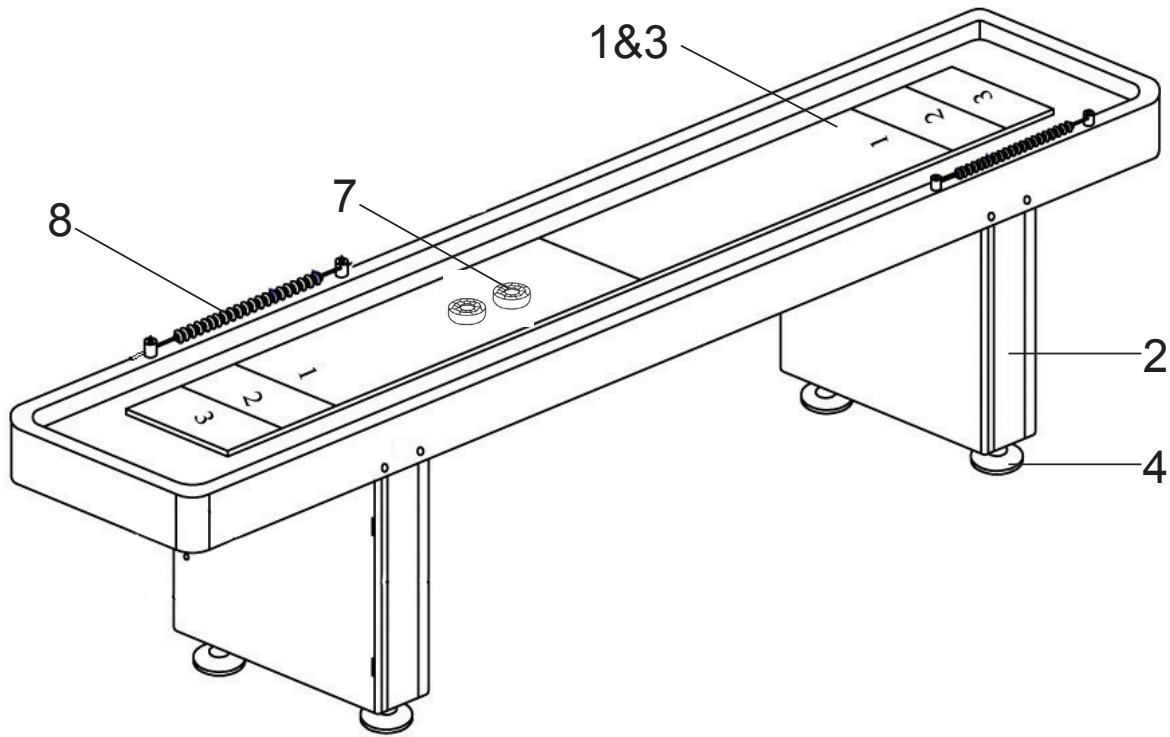

# 12 FOOT DK. CHERRY SHUFFLEBOARD TABLE - NG1214



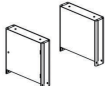

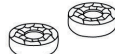
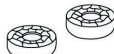
## Parts List

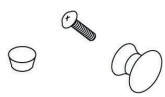

### PARTS

<p><b>#1&amp;3</b> NGP2617</p>  <p>TABLE BODY AND PLAYFIELD 12'</p>	<p><b>#2</b> NGP2602</p>  <p>LEG PIECE</p>	<p><b>#4</b> NGP2603</p>  <p>LEG LEVELER</p>	<p><b>#7</b> NGP2606</p>  <p>RED PUCK</p>	<p><b>#7</b> NGP2607</p>  <p>BLUE PUCK</p>	<p><b>#8</b> NGP2608</p>  <p>MANUAL SCORER</p>	<p><b>#10&amp;12</b> NGP2610</p>  <p>SCREW CAP &amp; DOOR HANDLE</p>
--	---	---	--	--	---	---

### HARDWARE PACK - NGP2604

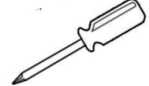
<p><b>#5</b></p>  <p>2-1/4" BOLT</p>	<p><b>#6</b></p>  <p>FLAT WASHER</p>	<p><b>#9</b></p>  <p>1-1/2" SCREW</p>	<p><b>#11</b></p>  <p>WRENCH</p>	<p>ADDITIONAL EQUIPMENT REQUIRED:</p>  <p>PHILLIPS HEAD SCREWDRIVER</p>
---	---	--	---	---