

HOOPS DUAL ELECTRONIC BASKETBALL GAME ASSEMBLY INSTRUCTIONS



NG2237BL





































THANK YOU!

Thank you for purchasing this product.

We work around the clock and around the globe to ensure that our products maintain the highest possible quality. However, in the rare instance that your product is defective or missing parts, contact your retailer, or call 800-759-0977, to submit parts requests or warranty claims. Please read the warranty information at the back of these assembly instructions for further details.

**IMPORTANT! PLEASE READ THESE ASSEMBLY INSTRUCTIONS
IN ENTIRETY BEFORE ASSEMBLING YOUR PRODUCT.**

PARTS IDENTIFIER (NOT TO SCALE)

#1  REAR TOP LEG 2 pcs	#2  REAR MIDDLE LEG 2 pcs	#3  REAR BOTTOM LEG 2 pcs	#4  REAR BASE 1 pc	#5  REAR CROSS BASE 1 pc
#6  BACK ARM 2 pcs	#7  CENTER TOP LEG 2 pcs	#8  CENTER MIDDLE LEG 2 pcs	#9  CENTER BASE 1 pc	#10  MIDDLE ARM 2 pcs
#11  FRONT ARM 2 pcs	#12  HINGE 2 pcs	#13  LEAN BAR 1 pc	#14  FRONT CROSS BRACE 1 pc	#15  RETAINING HOOK 2 pcs
#16  BALL RETURN NET 1 pc	#17  BACKBOARD 1 pc	#18  RIM WITH NET 2 pcs	#19  SUPPORT PLATE 2 pcs	#20  60MM BOLT 2 pcs
#21  ELECTRONIC SCOREBOARD 1 pc	#22  BASKETBALL 6 pcs	#23  PUMP WITH NEEDLE 1 pc	#24  35MM BOLT 14 pcs	#25  20MM X 5MM BOLT 4 pcs
#26  20MM X 6MM BOLT 8 pcs	#27  45MM BOLT 4 pcs	28  40MM BOLT 2 pcs	#29  3/4" SCREW 8 pcs	#30  FLAT WASHER 30 pcs
#31  LOCKNUT 30 pcs	#32  LOCKNUT 4 pcs	#33  WRENCH 1 pc	#34  HEX WRENCH 1 pc	#35  AC/DC POWER SUPPLY 1 pc
#36  FLAT WASHER 4 pcs				

Please see Parts List at end of manual for part number when ordering parts. For replacement parts please call 800-759-0977.

ASSEMBLY TIPS

1. Find a clean, level surface to begin the assembly of your game. The game will be partially assembled upside down and then turned over onto its legs. This is a heavy game and turning it over will require at least two strong adults.
2. Remove all of the contents from box and verify that you have all of the parts shown on the Parts Identifier before you begin assembly. **Note: Some parts may be pre-installed or pre-assembled.**
3. Some figures or drawings may not look exactly like your product. Please read and understand the text before beginning each assembly step.
4. **When installing parts that have more than one screw or bolt, hand tighten all screws or bolts in place before finishing tightening with screwdriver or hex wrench.**
5. Electric screwdrivers may be helpful during assembly; however, please set a low torque and use extreme caution because screws may be stripped or overtightened if the electric screwdriver's torque is set too high.

WARNINGS!

READ AND FOLLOW ALL ASSEMBLY, OPERATION AND SAFETY INSTRUCTIONS CAREFULLY.

CHOKER HAZARD - THIS TABLE CONTAINS SMALL BALLS AND PARTS - NOT
SUITABLE FOR CHILDREN UNDER 3 YEARS OF AGE.

PINCH HAZARD – USE CAUTION WHEN FOLDING AND UNFOLDING THE GAME.

ASSEMBLY INSTRUCTIONS

1. Attach ELECTRONIC SCOREBOARD #21 to the back of the BACKBOARD #17 with 20mm x 5mm BOLT #25, FLAT WASHER #36 and LOCKNUT #32. Attach the sensors to the back of the BACKBOARD as shown with 3/4" SCREW #29.

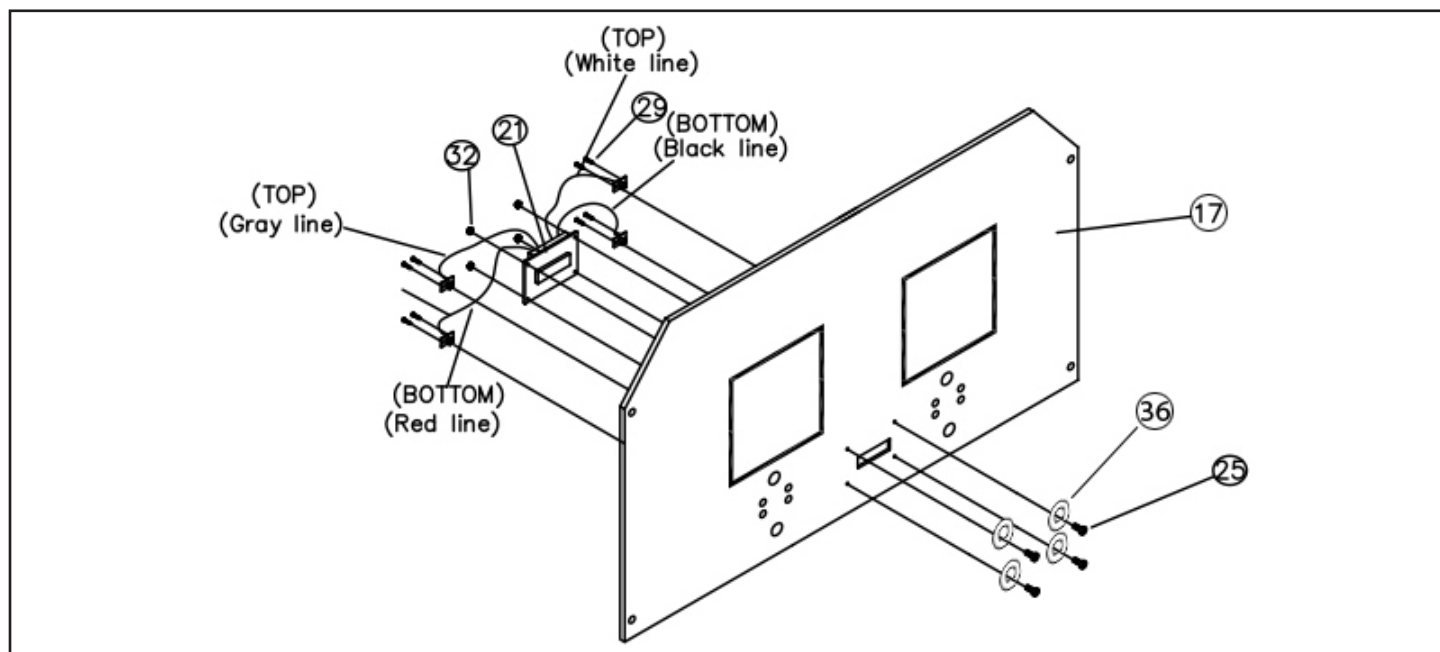

2. Attach each RIM with NET #18 to the front of the BACKBOARD as shown with 20mm x 6mm BOLT, SUPPORT PLATE #19, FLAT WASHER #30 and LOCKNUT #31.

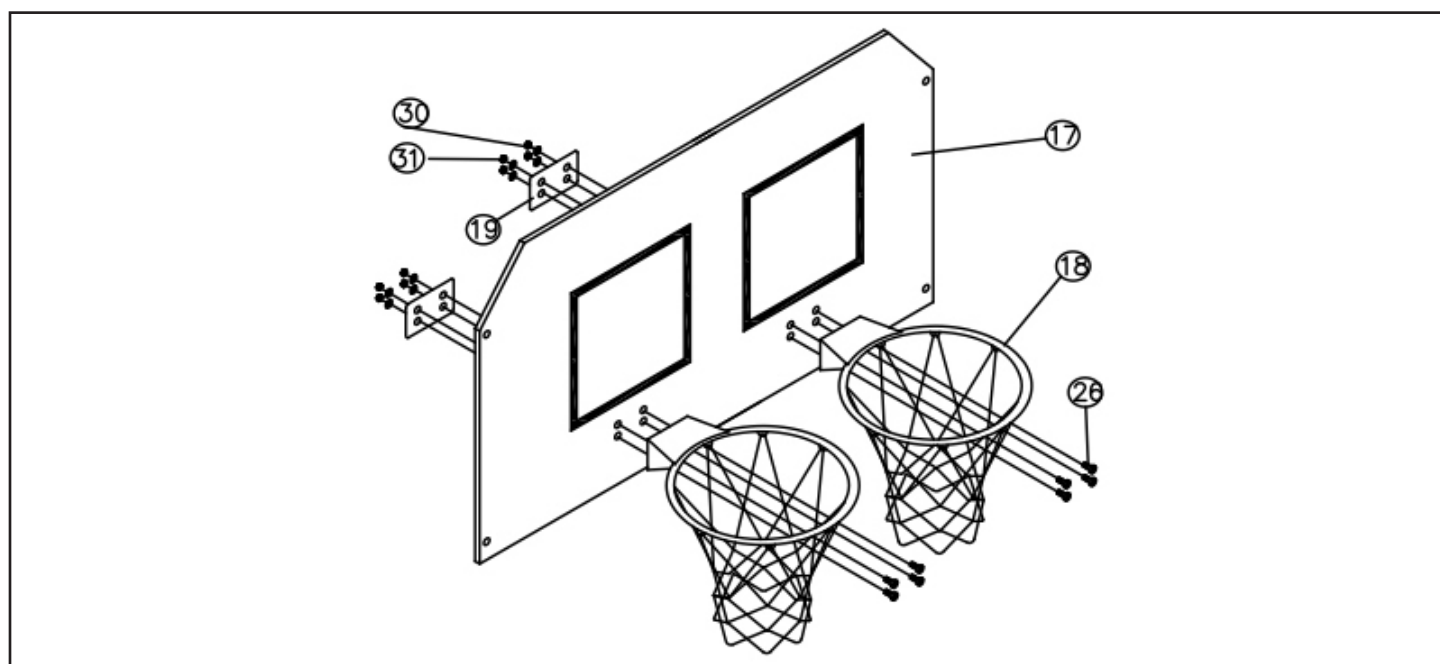

ASSEMBLY INSTRUCTIONS (CONT.)

3. Begin Rear Frame Assembly by connecting one REAR BOTTOM LEG #3 to each side of the REAR BASE #4 – push buttons lock into place. Connect one REAR MIDDLE LEG #2 to each REAR BOTTOM LEG #3 – push buttons lock into place.

Connect one REAR TOP LEG #1 to each REAR MIDDLE LEG #2.

4. Attach the assembled BACKBOARD to the REAR TOP LEG #1 with 45mm BOLT #27, FLAT WASHER #30 and LOCKNUT #31. Attach the BACKBOARD to the REAR MIDDLE LEG #2 with 45mm BOLT #27, FLAT WASHER #30, RETAINING HOOK #15 and LOCKNUT #31.

5. Attach REAR CROSS BRACE #5 between each REAR MIDDLE LEG #2 with 35mm BOLT #24, FLAT WASHER #30 and LOCKNUT #31.

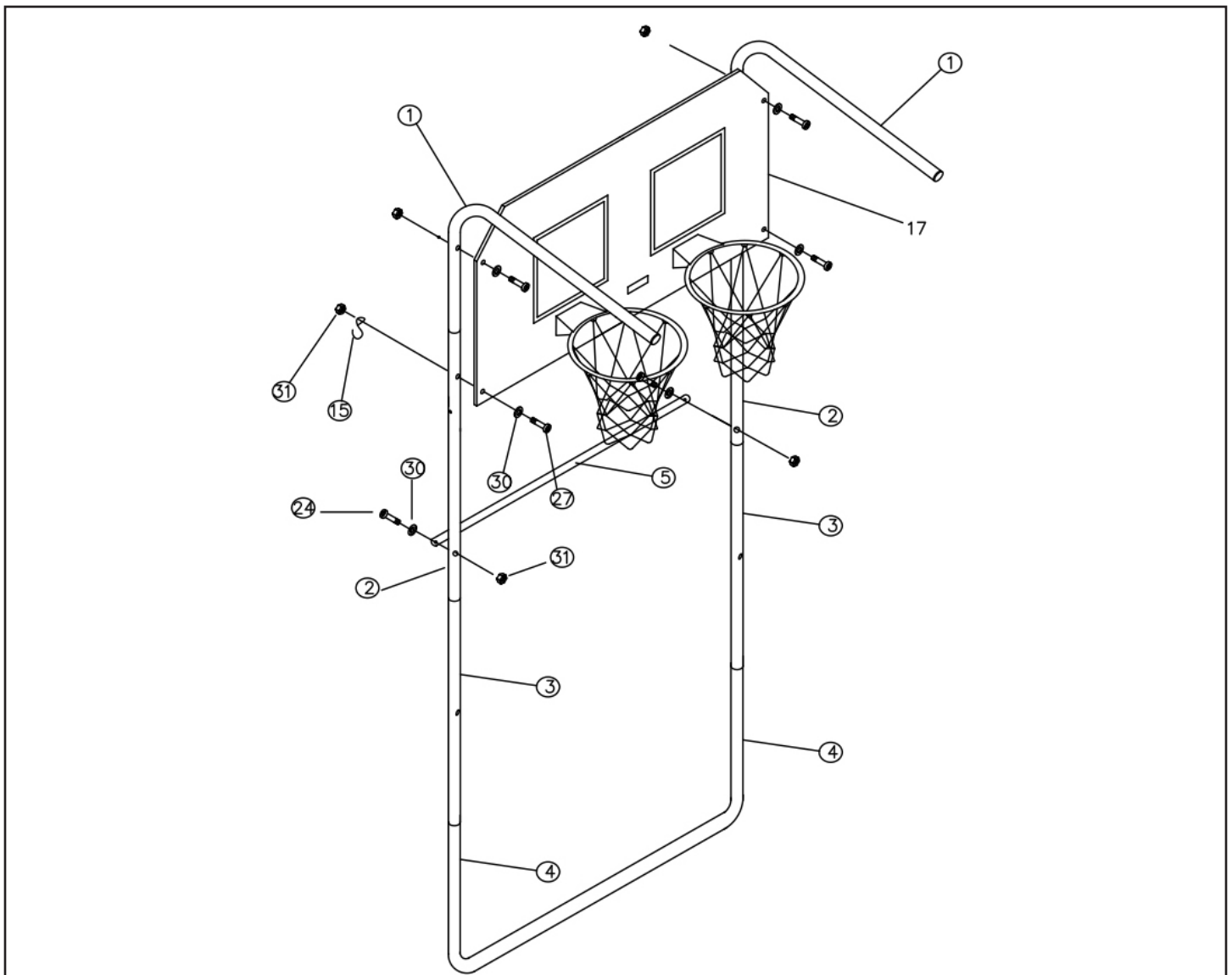

ASSEMBLY INSTRUCTIONS (CONT.)

6. Begin Center Frame Assembly by connecting one CENTER MIDDLE LEG #8 to each side of CENTER BASE #9. Connect one CENTER TOP LEG #7 to each CENTER MIDDLE LEG #8 – push buttons lock into place.

7. Attach one CENTER TOP LEG #7 to each REAR MIDDLE LEG #2 with 35mm BOLT #24, FLAT WASHER #30 and LOCKNUT #31.

8. Attach one BACK ARM #6 to each REAR BOTTOM LEG #3 as shown with 35mm BOLT #24, FLAT WASHER #30 and LOCKNUT #31. Attach each BACK ARM #6 to CENTER BASE #9 as shown with 60mm BOLT #20, FLAT WASHER #30 and LOCKNUT #31.

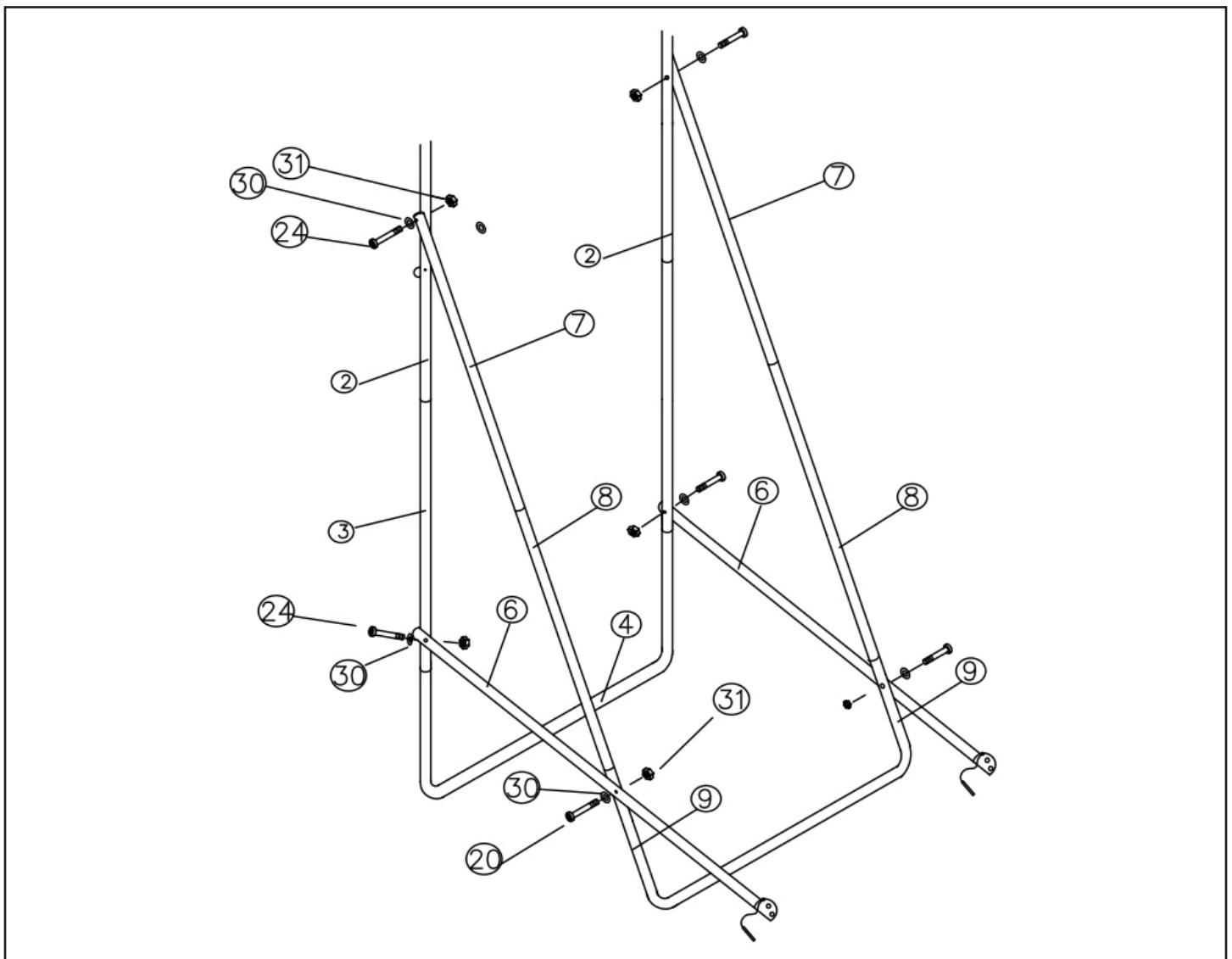

ASSEMBLY INSTRUCTIONS (CONT.)

9. Continue Front Arm Assembly by attaching one MIDDLE ARM #10 to the bracket on the end of each BACK ARM #6 with 40mm BOLT #28, FLAT WASHER #30 and LOCKNUT #31. Attach one FRONT ARM #11 to the end of each MIDDLE ARM #10 with 35mm BOLT #24, FLAT WASHER #30 and LOCKNUT #31. [Note: Push buttons should face inward.] Attach one HINGE #12 (with hinge folding down) to each MIDDLE ARM #10 and FRONT ARM #11 with 35mm BOLT #24, FLAT WASHER #30 and LOCKNUT #31. [Note: HINGES should attach to the inside edge of the ARMS.]

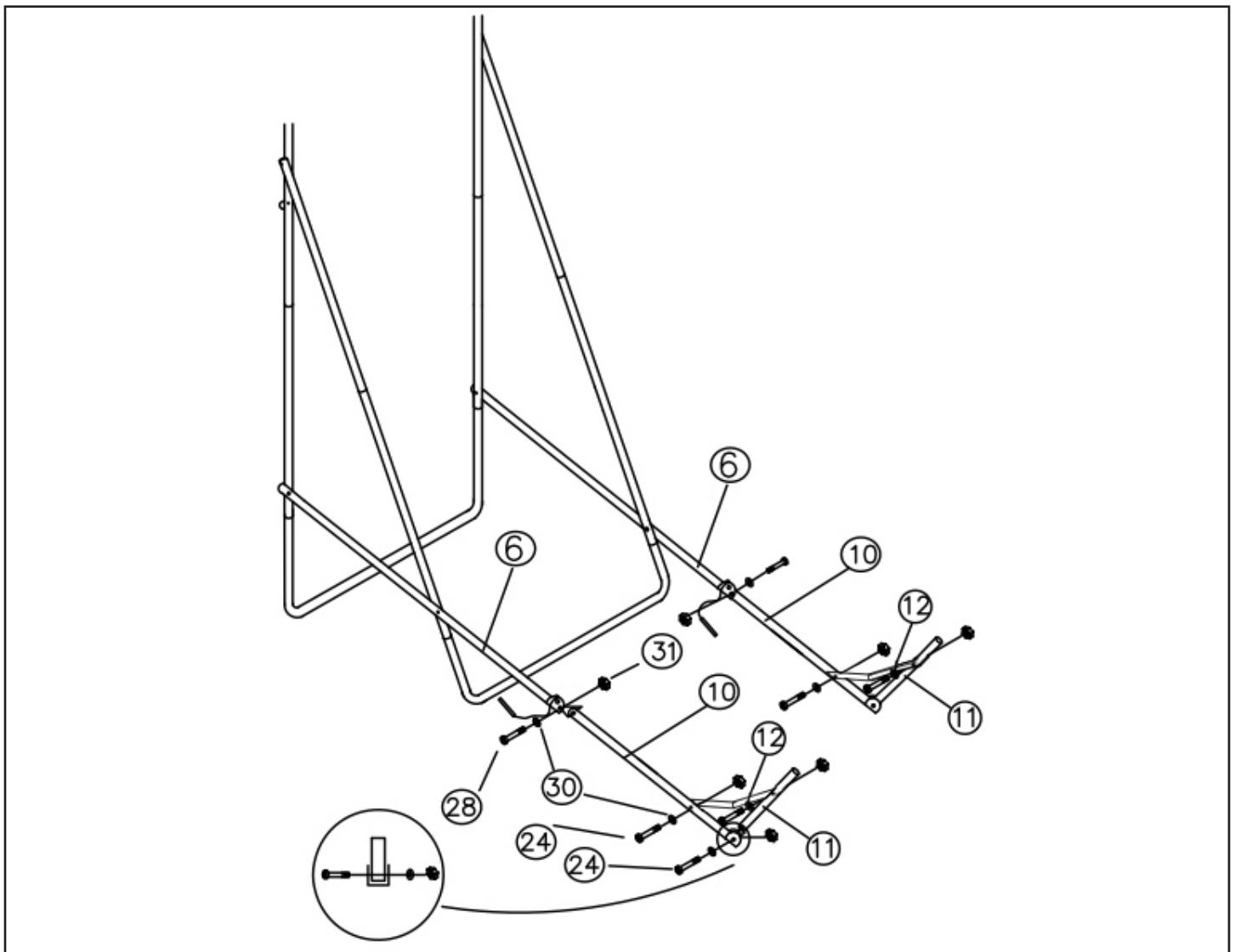

ASSEMBLY INSTRUCTIONS (CONT.)

10. Slide LEAN BAR #13 through the front opening in BALL RETURN NET #16. Connect each end of the LEAN BAR #13 to each FRONT ARM #11 – push buttons lock into place.

11. Slide BALL RETURN NET #16 over the REAR TOP LEGS #1 as shown. Wrap lower straps around RETAINING HOOKS #15 on the back of the BACKBOARD to tighten. Clip straps together around REAR MIDDLE POLE #2.

12. Attach FRONT CROSS BRACE #14 to each side of the LEAN BAR #13 and across the inside edge of the BALL RETURN NET as shown with 35mm BOLT #24, FLAT WASHER #30 and LOCKNUT #31. Wrap fastening strap around LEAN BAR to tighten.

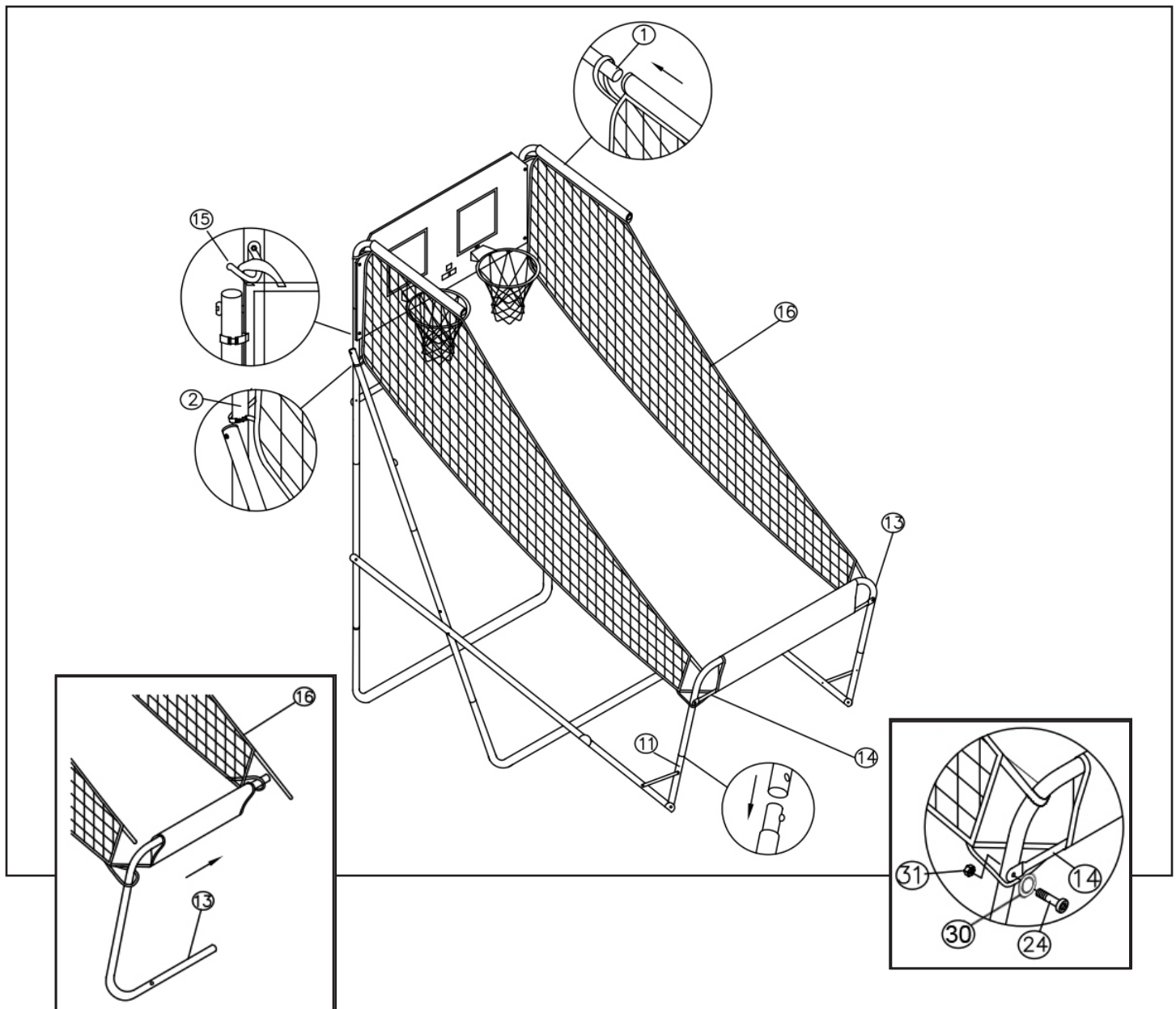

CONGRATULATIONS!

You have now assembled your Basketball Game. Please note the Care and Use instructions below to ensure years of trouble free use of your game table.

CARE AND USE

1. This product is intended for INDOOR use only.
2. Do NOT sit, climb or lean on the game.
3. To inflate the basketballs, first remove the needle from the storage compartment in the pump handle and thread it into the end of the pump. Moisten needle before inserting into the basketball. Inflate basketball to desired size. Return needle to the storage compartment after inflating basketballs.
4. To play the game, first plug the power supply into the electronic scoreboard and then plug it into the wall outlet. Make sure the cord is placed out of the way to prevent players from tripping or becoming entangled.
5. The electronic scoreboard will turn off automatically after 5 minutes of inactivity. Press the reset button to restart the game.
6. Unplug the game after use. Always grasp the power supply at the outlet. Do not pull the cord to remove the plug from the wall outlet.
7. To store the game, fold both hinges down, lift the front of the game and fold the arms toward the backboard. Lock the arms closed with the attached pins.

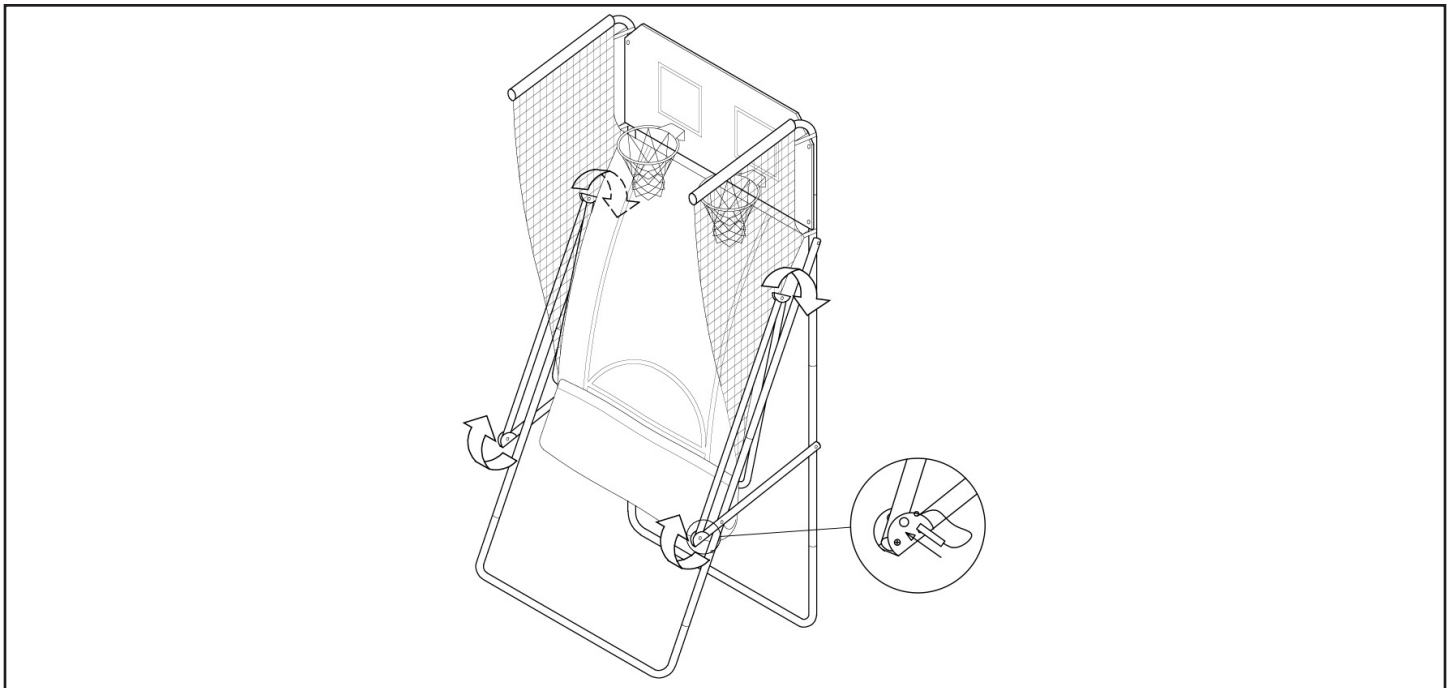

How to Play:

The object of the game is to score the most points in each round. Each game consists of 3 possible rounds. The electronic scoreboard will keep the time – sound effects will indicate the end of each round. Players should continue shooting basketballs until the scoreboard indicates the end of the round. If enough points are scored, the player(s) may continue to play further rounds. After the game ends, the scoreboard will display the point total for each player.

180-DAY LIMITED WARRANTY

This product is warranted to the original purchaser to be free from defects in material or workmanship for a period of 180 days from the date of the original retail purchase.

This warranty does not cover defects or damage due to improper installation, alteration, accident or any other event beyond the control of the manufacturer. Defects or damage resulting from misuse, abuse or negligence will void this warranty. This warranty does not cover scratching or damage that may result from normal usage.

This product is not intended for institutional or commercial use; the manufacturer does not assume any liability for such use. Institutional or commercial use will void this warranty.

This warranty is nontransferable and is expressly limited to the repair or replacement of the defective product. During the warranty period, the manufacturer shall repair or replace defective parts at no cost to the purchaser. Shipping charges and insurance are not covered and are the responsibility of the purchaser. Labor charges and related expenses for removal, installation or replacement of the product or components are not covered under this warranty.

The manufacturer reserves the right to make substitutions to warranty claims if parts are unavailable or obsolete.

The manufacturer shall not be liable for loss of use of the product or other consequential or incidental costs, expenses or damages incurred by the consumer of any other use. The user assumes all risk of injury resulting from the use of this product.

This warranty is expressly in lieu of all other warranties, expressed or implied, including warranties of merchantability or fitness for use to the extent permitted by Federal or state law. Neither the manufacturer nor any of its representatives assumes any other liability in connection with this product.

All warranty claims must be made through the retailer where the product was originally purchased. A purchase receipt or other proof of date of purchase will be required to process all warranty claims. The model number and part numbers found within the assembly instructions will be required when submitting any parts requests or warranty claims.







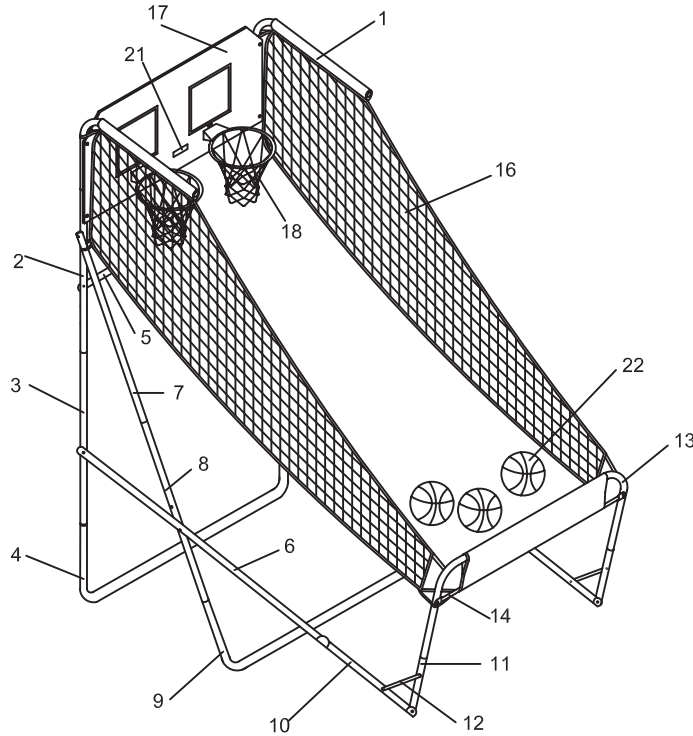





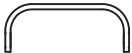

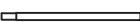



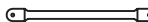

For further warranty information or inquiries, please call 800-759-0977

HOOPS DUAL ELECTRONIC BASKETBALL - NG2237BL









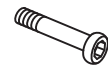

Parts List



PARTS

#1 NGP5620  REAR TOP LEG	#2 NGP5621  REAR MIDDLE LEG	#3 NGP5622  REAR BOTTOM LEG	#4 NGP5623  REAR BASE	#5 NGP5624  REAR CROSS BASE	#6 NGP5625  BACK ARM	#7 NGP5626  CENTER TOP LEG
#8 NGP5627  CENTER MIDDLE LEG	#9 NGP5628  CENTER BASE	#10 NGP5629  MIDDLE ARM	#11 NGP5630  FRONT ARM	#12 NGP5631  HINGE	#13 NGP5632  LEAN BAR	#14 NGP5633  FRONT CROSS BRACE
#15 NGP5634  RETAINING HOOK	#16 NGP5635B  BALL RETURN NET	#17 NGP5636B  BACKBOARD	#18 NGP5637  RIM WITH NET	#19 NGP5638  SUPPORT PLATE	#21 NGP5639  ELECTRONIC SCOREBOARD	#22 NGP2217  BASKETBALL
#23 NGP5640  PUMP WITH NEEDLE	#35 NGP5641  AC/DC POWER SUPPLY					

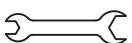
HARDWARE PACK - NGP5642

#20  60MM BOLT	#24  35MM BOLT	#25  20MMX5MM BOLT	#26  20MMX6MM BOLT	#27  45MM BOLT	#28  40MM BOLT	#29  1/4" SCREW
#30  FLAT WASHER	#31  LOCK NUT	#32  LOCK NUT	#33  WRENCH	#34  HEX WRENCH	#36  FLAT WASHER	