

AQUAQUIK®

UNIVERSAL SOLAR HEATER

OWNER'S MANUAL

MODEL 4512

IMPORTANT SAFETY RULES

Read all instructions **BEFORE**
assembling and using
this product.
KEEP THIS MANUAL.



IMPORTANT DO NOT RETURN PRODUCT TO STORE

For technical assistance and missing parts, call Customer Service toll-free

1.888.382.5988

(press 135 at any time)

Monday through Friday, 8 am to 5:00pm MST

Saturday, 8:00am to 1:00pm MST



**READ ALL INSTRUCTIONS BEFORE ASSEMBLING AND USING
THIS PRODUCT. FAILURE TO FOLLOW INSTRUCTIONS
CAN CAUSE SEVERE AND/OR FATAL INJURY.**

In this manual, the callout has the following meaning:

CAUTION

This heading is used when injury, accidents or damage to the device or the operator may occur if the operating instructions, work instructions, work procedures, etc. are NOT strictly adhered to.

**IMPORTANT
DO NOT RETURN PRODUCT TO STORE**

For technical assistance and missing parts, call Customer Service toll-free

1.888.382.5988

(press 135 at any time)

Monday through Friday, 8 am to 5:00pm MST

Saturday, 8:00am to 1:00pm MST

TABLE OF CONTENTS

1. General Information	5
How It Works	5
Workmanship	5
Safety Notes	5
Damage During Delivery	5
Resultant Damages	5
Unpacking Your Filter System	5
Tools & Equipment Required	5
Know Your Pool	5
Solar Heater Location	6
2. Parts List/Reference	7
3. Installation Instructions	8
Heater – Filter – Pool Layout	8
Heater – Pool Connections	9
• Pools with 1¼" or 1½" Diameter Unthreaded Hoses	10
• Pools with 2¼" Diameter Threaded Hoses	10
4. Initial Operation	11
5. Maintenance	12
6. Troubleshooting	13
7. Warranty	14
8. Appendix: Exploded Parts Diagram	16

**READ AND FOLLOW ALL INSTRUCTIONS IN THIS MANUAL PRIOR
TO INSTALLATION AND USE OF THIS PRODUCT.**

SAFETY WARNINGS

- Carefully read and adhere to all CAUTION and NOTE notices located throughout this manual. Failure to comply with these instructions can cause serious injury, death, or damage to the unit.
- Do NOT allow children to operate this product.
- Always turn the filter system to a setting that does not allow flow to the pool return when installing or working on the solar heater.
- Install this product away from the pool to prevent children from using the heater as a way to access the pool.
- NEVER service this unit with the pool pump running.
- Do not use any petroleum based lubricant. Petroleum based products will destroy plastic parts.

**THESE CAUTION WARNINGS ARE NOT INTENDED TO INCORPORATE ALL
POSSIBLE INSTANCES FOR RISK AND/OR SEVERE INJURY. THE POOL
OWNER SHOULD ALWAYS EXERCISE CAUTION AND COMMON SENSE WHEN
UTILIZING THEIR SWIMMING POOL AND OPERATING EQUIPMENT.**

1. GENERAL INFORMATION

This manual provides information relating to the installation, utilization and maintenance of our solar heater. We recommend you read this manual in its entirety and keep it for future reference.

The solar heater you just purchased for your above ground pool is simple to install and effortless to operate once connected. The installation instructions included in this manual are based on a few assumptions: 1) you have an existing above ground pool that is completely set up and filled with water, 2) your above ground pool is equipped with a pump-operated water filtering system, and 3) you have the necessary hoses needed to feed water in and out of your pool and filter system.

These assumptions are necessary as the solar heater, once installed, will be completely dependent upon your pool's filter pump to push water in and through the heater's solar coils.

How It Works

When properly installed, the solar heater will be connected to your filter and your pool by two hose connections: One hose will feed cold, filtered pool water from your pump into one port of the solar heater. The other hose will feed sun warmed water from the other port of the solar heater to your pool via the pool return inlet in your pool. As cold water is fed into the solar heater, it travels through the solar coils where it is heated by the sun before it is delivered back into your swimming pool.

Unpacking Your Solar Heater

Carefully remove the product and all component parts from the box. Make certain all parts are present before beginning assembly. See Section 2, Parts List/Reference.

Refer to Appendix for a complete EXPLODED VIEW PARTS DIAGRAM

Tools & Equipment Required

The following items are not included with your new solar heater, but will be required for proper installation and operation:

- #2 Phillips Screwdriver
- Silicone based lubricant

Know Your Pool

Before you begin installation it is a good idea to know certain specifications of your pool:

How big is your pool?

How many gallons does it hold?

What size hose does it use? (i.e. 1¼" dia, 1½" dia or 2¼" dia)

What kind of hose connection does your pool use? (i.e. threaded/unthreaded)

What location will position the heater for maximum sun exposure?

Solar Heater Location

Your solar heater needs to be located on a hard level surface. You will need to position the heater lower than the pool's water level and at a safe distance away from the pool (see Safety Warnings, page 4).

NOTE: The solar heater is to be installed between the filter and the pool water inlet, AFTER the water is filtered. The heater must come after the filter to prevent buildup in the tubing.

CAUTION

Before loosening any threaded connections on your filter, pump or pool, be sure that the suction and pressure hoses on the filter are closed. or blocked to prevent water flow.

2. PARTS LIST/REFERENCE

Primary Components

MAIN BASE WITH STAND (1)

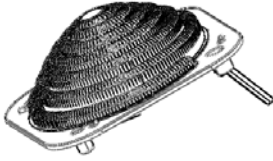

1 ¼"-1 ½" HOSE REDUCER (2)

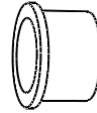

COLLARED TUBE ADAPTER with O-RING (1)

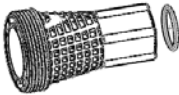

HOSE CLAMP (2)



THICK CONNECTOR GASKET (1)



LONG FILTER HOSE (1)



SIDE HOSE CONNECTOR with O-RING (2)

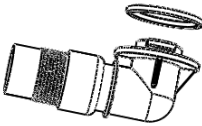

SHORT HOSE (1)



CLEAR DOME with CLOTH COVER (1)

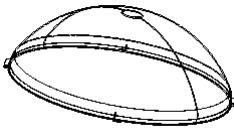

OWNER'S MANUAL

Note: some parts may be pre-installed at the factory.

NOTE: *Parts not shown to scale*

3. INSTALLATION INSTRUCTIONS

Heater – Filter – Pool Layout

The system layouts below will help you install the solar heater(s) to your above ground pool.

BEFORE INSTALLING SOLAR HEATER

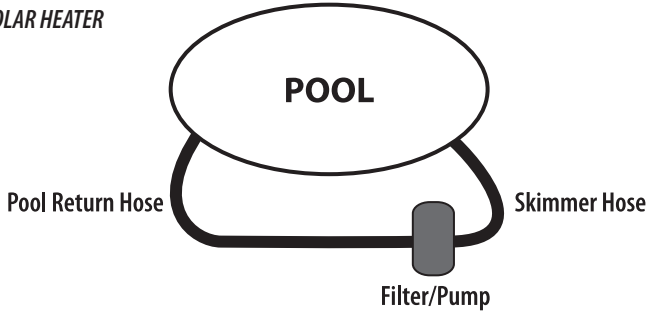

AFTER INSTALLING SOLAR HEATER

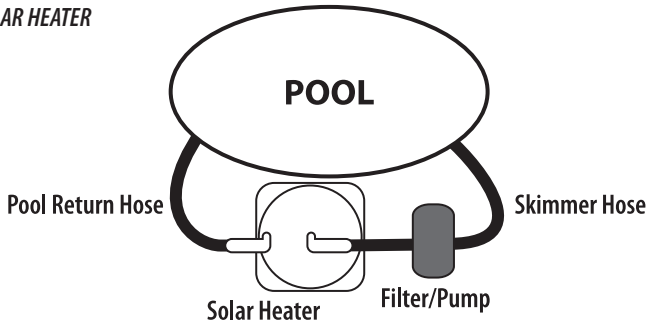

LINKING MULTIPLE SOLAR HEATERS

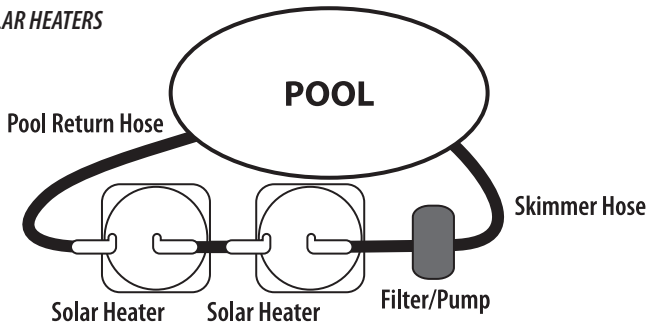

NOTE: *Not shown to scale*

NOTE: The connections here show the water flowing into the Solar Heater through the center connector and out through the side hose connector. This diagram is for reference only as the flow may be reversed if you choose (i.e. the water flow coming in through the side hose connector and out through the center hose connector).

Heater - Pool Connections

These instructions assume that the pool and filter system are already assembled and there is a hose attached to the pool return (pool water inlet).

Place the solar heater in a location where it will receive the greatest amount of sunlight and at least 10 feet away from pool.

1) Heater - Filter Pump Connection

- a) Turn off filter pump.
- b) Block water flow at the pool return inlet to prevent water from flowing through the pool return hose.
- c) Detach the pool return hose from your filter system and set aside.

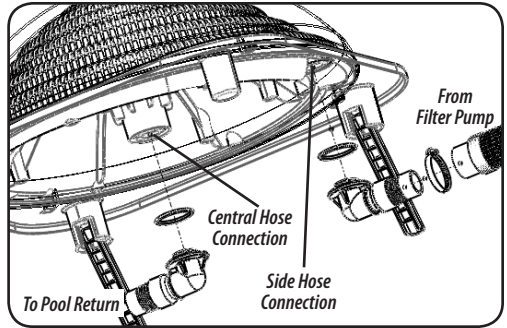

NOTE: If you are using an INTEX® filter, remove the hose adapter from the filter port as well.

- d) Locate the side hose connector on the underside of the solar heater.
- e) Apply a small amount of silicone based lubricant to the outer edge of the side hose connector, so that the long filter hose slides on easily.
- f) Using a hose clamp, secure one end of the long filter hose to the side hose connector.
- g) Using a hose clamp, secure the other end of the long filter hose to the pool return port on your filter system (the port where the pool return hose was previously connected.)

NOTE: If the solar heater needs to be further from the filter than the hoses allow for, you may need to purchase a longer hose with 1½" diameter openings. A 1½"-1½" coupler is needed to allow you to connect an additional hose if necessary (not included). In this case make certain you have two hose clamps to secure the hoses to the coupler. If hoses are too wide to fit the hose connector, put the ¼"-1½" tube reducer on the hose connector and continue.

2) Heater – Pool Connections

For Pools with 1¼" or 1½" diameter unthreaded hoses GO TO Step A

For Pools that use 2¼" threaded hoses GO TO Step B

A. Pools with 1¼" or 1½" Diameter Unthreaded Hoses

1. Locate the central hose connector on the underside of the solar heater.
2. Apply a small amount of silicone based lubricant to the remaining edge of the central hose connector.
3. Using the hose clamp, secure the loose end of your existing pool return hose to the center hose connector.

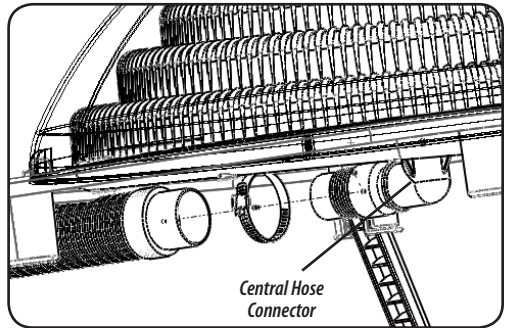

SKIP B and GO TO Step 3

B. Pools with 2¼" Diameter Threaded Hoses

1. Attach the collared tube adapter with o-ring to the central hose connector under the base. Make sure the o-ring is in the collared tube adapter prior to attachment.
2. Screw your existing pool return hose onto the collard tube adapter. Be sure to place the thick connector gasket between the hose and the adapter for a tight seal.

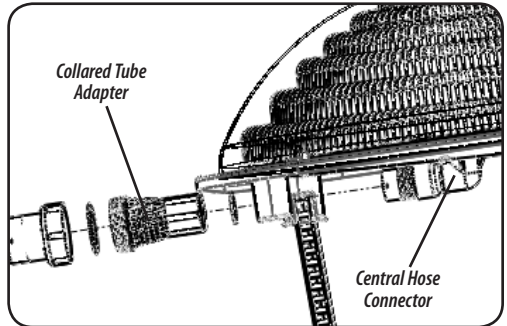

CONTINUE ON TO Step3

3) Solar Heater Placement

Extend the two legs on the underside of the heater and face the heater in the direction of the sun's natural path.

4) Solar Heater System

The basic solar heater assembly should resemble the figure on right.

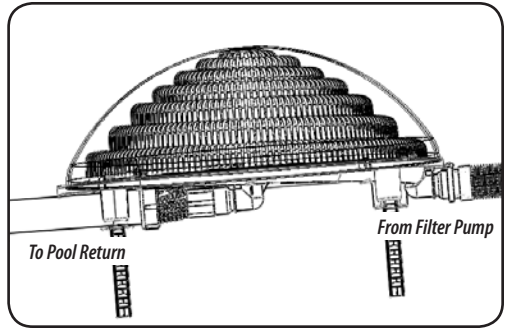

CAUTION

Ensure ALL hose connections are tight and the hoses are NOT kinked or bent at severe angles. If the hoses are leaking, check to make sure ALL of the parts that have O-Rings have them attached.

NOTE: The short hose is only used to connect multiple solar heaters together.

4. INITIAL OPERATION

Once the solar heater has been assembled and the hoses are connected to the filter pump and pool return, unblock the flow of water into the pool return hose and turn on the pump and filter system. Bubbles will shoot out of the return nozzle into the pool initially while air is pushed out of the solar heater. If this persists for longer than 2 or 3 minutes, check for and repair any leaks in the hoses or connections.

NOTE: Be sure to place your pool cover on at night to prevent heat loss.

5. MAINTENANCE

To prevent damage, the solar coils should always be covered with the clear acrylic dome included in the package. The solar heater should not require servicing or maintenance other than winterizing. Prior to the first frost, or at the end of your swim season, the solar heater should be removed from its connections to the pool and stored in a frost free location.

Cloth Cover

A dome cover is included which can be used to cover the solar heater during the hottest days when your pool water does not need additional heating assistance.

Winterizing

Drain all the water from the solar heater by disconnecting the tubes. Store in a location protected from frost. Reconnect the pool return tubes with a 1½"-1½" coupler (not included) or any properly sized 2-way valve if continued pool use is desired.

CAUTION

Do NOT allow standing water inside the solar heater to freeze. Water expands as it freezes and can rupture the solar coils on the heater.

6. TROUBLESHOOTING

Problem	Possibilities/Solutions
Does not appear to be heating the pool.	<ul style="list-style-type: none">• Check to make sure that water is flowing through the tubes. Check the flow strength at the pool inlet.• Has it been sunny?• Put your pool cover on at night to prevent heat loss.• Additional heaters may be necessary.
No initial bubbling after heater is connected and pump is on.	<ul style="list-style-type: none">• Check the setting of the filter to make sure it is returning water to the pool through the pool water inlet.• Check flow rate.
Bubbles continue to flow out of the pool water inlet well after the pump has been turned on.	<ul style="list-style-type: none">• Check the connections for a suction leak.• Check to make sure the flow rate is normal.• There could be a break in the tubing.• There could be a clog in the tubing, try to purge out the clog.
Leaking heater	<ul style="list-style-type: none">• Check the connector seals and replace or repair if defective.

7. LIMITED WARRANTY STATEMENT

The manufacturer warranties safe operation and reliability only under the following conditions:

- The solar heater is installed and operated according to the assembly and operating instructions.
- Only original replacement parts are used.
- Consumable parts do NOT fall under the warranty.

General Terms

This Limited Warranty applies to the enclosed product (the "Product") distributed by Great American Duck Races, Inc., an Arizona corporation (doing business as Great American Marketing and Events) ("GAME").

GAME warrants that the Product will be free from defects in materials and workmanship under normal use for a period of one (1) year from the date of purchase. (Your dated sales or delivery receipt, showing the date of your Product purchase, is your proof of the purchase date.) During the warranty period, GAME will repair or replace any defective parts at no charge.

All defective parts that are replaced by GAME will be replaced, at GAME's discretion, with either new parts or used parts that meet or exceed performance specifications for new parts. All parts removed from the Product under this warranty will become the property of GAME. Repair or replacement of any parts will not serve to extend the one (1) year warranty period.

This Limited Warranty does not apply to expendable parts. This Limited Warranty does not extend to any product (a) from which the serial number has been removed or (b) that has been damaged or rendered defective (i) as a result of accident, misuse, abuse or other external causes; (ii) by operation outside the usage parameters stated in the Instruction Sheet that shipped with the Product; (iii) by the use of parts not manufactured or sold by GAME; or (iv) by modification or service by anyone other than GAME or an authorized GAME distributor.

If a defect is identified within the warranty period, please contact GAME.

EXCEPT FOR THE LIMITED WARRANTY SET FORTH ABOVE, GAME EXPRESSLY DISCLAIMS ALL OTHER WARRANTIES, WHETHER EXPRESS OR IMPLIED, ORAL OR STATUTORY (INCLUDING, WITHOUT LIMITATION, WARRANTIES OF MERCHANTABILITY AND FITNESS FOR A PARTICULAR PURPOSE). ANY IMPLIED WARRANTIES THAT MAY BE IMPOSED BY LAW ARE LIMITED TO THE TERMS OF THE ABOVE LIMITED WARRANTY.

Limitation of Liability

EXCEPT FOR THE LIMITED WARRANTY DESCRIBED ABOVE, IN NO EVENT WILL GAME HAVE ANY LIABILITY OF ANY KIND WHATSOEVER (WHETHER UNDER CONTRACT, TORT, OR ANY OTHER THEORY OF LEGAL LIABILITY) TO ANY PERSON WITH RESPECT TO THE PRODUCT (INCLUDING, WITHOUT LIMITATION, (A) ANY USE OR MISUSE OF THE PRODUCT, (B) ANY FAILURE OR MALFUNCTION OF THE PRODUCT, (C) ANY BODILY INJURY, DEATH, LOSS OF OR DAMAGE TO ANY PROPERTY, OR ANY OTHER DAMAGES RELATED TO OR RESULTING FROM THE PRODUCT OR ITS USE (INCLUDING, WITHOUT LIMITATION, ANY SPECIAL, INCIDENTAL, CONSEQUENTIAL OR PUNITIVE DAMAGES, LOST PROFITS, LOSS OF USE), EVEN IF GAME OR GAME'S AUTHORIZED REPRESENTATIVES HAVE BEEN ADVISED OF THE POSSIBILITY OF ANY SUCH DAMAGES.

Severability

Any provision of this Limited Warranty which is prohibited or unenforceable in any jurisdiction will, as to such jurisdiction, be ineffective to the extent of such prohibition or unenforceability without invalidating the remaining portions hereof or affecting the validity or enforceability of such provision in any other jurisdiction.

Venue and Choice of Law

This Limited Warranty is applicable in all countries. This Limited Warranty will be governed by the laws of the State of Arizona (regardless of any conflict of laws rules), and any disputes arising from this Limited Warranty will be resolved in Phoenix, Arizona.

Entire Agreement

This Limited Warranty is understood to be the complete and exclusive agreement between GAME and the purchaser of the Product, superseding all prior agreements, oral or written, and all other communications between such parties relating to the Product. No employee or representative of GAME or any other party is authorized to make any warranty in addition to the limited warranty set forth above.

**IMPORTANT
DO NOT RETURN PRODUCT TO STORE**

For technical assistance and missing parts, call Customer Service toll-free

1.888.382.5988

(press 135 at any time)

Monday through Friday, 8 am to 5:00pm MST

Saturday, 8:00am to 1:00pm MST

8. APPENDIX

Key Part Name	Qty
1 Main Base with Stand	1
2 Clear Dome with Cloth Cover	1
3 Side Hose Connector	2
4 O-Ring Seal	2
5 Long Filter Hose	1
6 Short Hose	1
7 Hose Clamp	2
8 Collared Tube Adapter	1
9 O-Ring	1
10 Thick Connector Gasket	1
11 1½" to 1¼" Hose Reducer	2

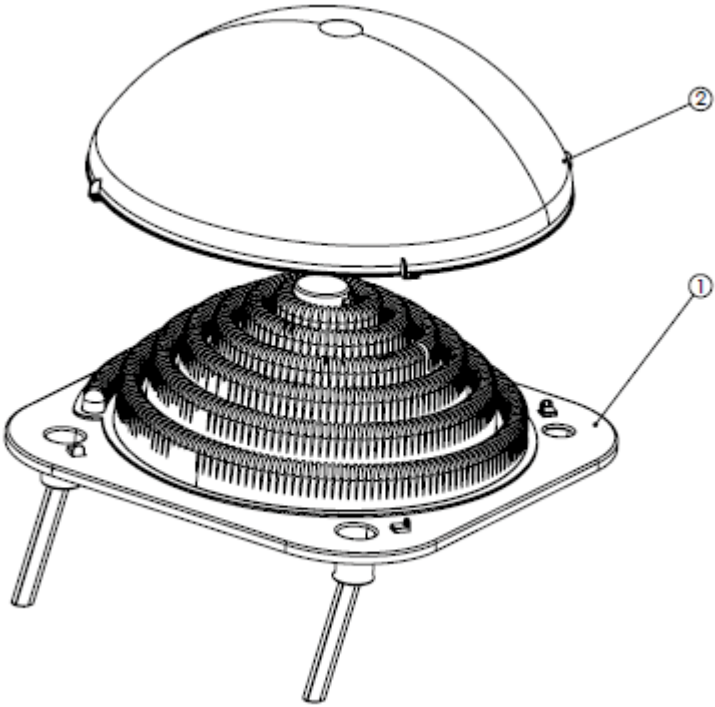

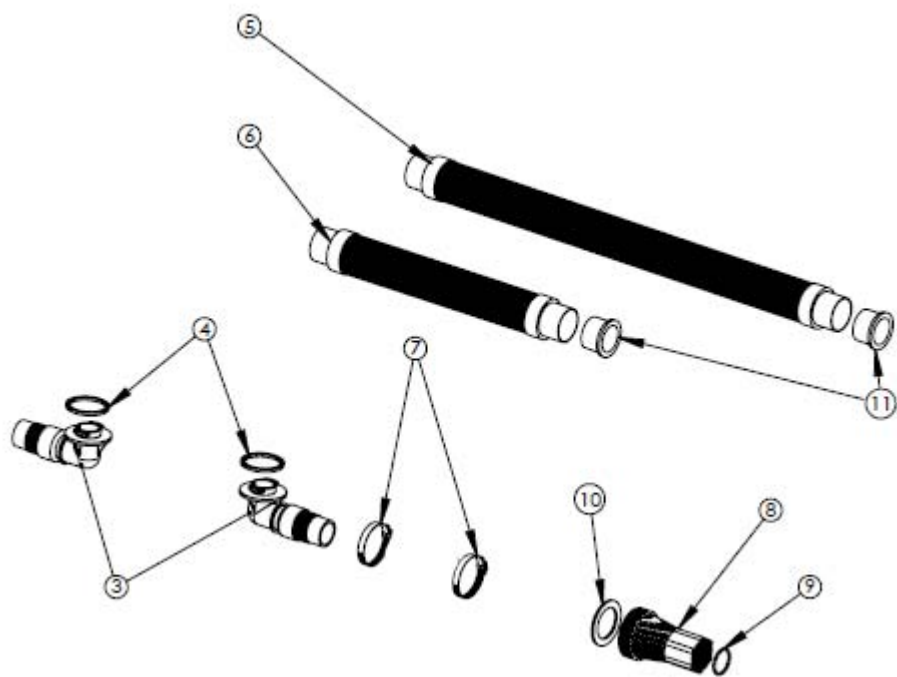

IMPORTANT
DO NOT RETURN PRODUCT TO STORE

For technical assistance and missing parts, call Customer Service toll-free

1.888.382.5988

(press 135 at any time)

Monday through Friday, 8 am to 5:00pm MST

Saturday, 8:00am to 1:00pm MST

Look for other GAME products at your favorite store
or visit our website, www.game-group.com/retailers.



Great American Merchandise & Events™
16043 N. 82nd Street
Scottsdale, AZ 85260-1800 U.S.A.

tel: 888.382.5988, 602.957.3825
fax: 602.957.7665
email: products@game-group.com
www.game-group.com/retailers